



SKCT DIGEST

VOLUME 16 ISSUE 12
14 MAY 2020

IN THIS ISSUE

- NEW VISTAS OF LEARNING
- FDP ORGANIZED
- FDPs ATTENDED
- TALK SERIES
- STUDENTS' PARTICIPATION
- FACULTY PARTICIPATION
- MEETINGS & DISCUSSIONS
- OUTREACH ACTIVITIES

EDITOR - IN - CHIEF

Dr Srinivasan Alavandar

Principal

SUB EDITOR

Dr V Thiyagarajan, S&H

EDITORIAL TEAM

Ms S Soundarya, CSE

Ms S Thenmozhi, ECE

Ms A Little Judy, EEE

NEW VJSTAS OF LEARNING

 **SRI KRISHNA COLLEGE OF TECHNOLOGY**
[An Autonomous Institution | Affiliated to Anna University and Approved by AICTE | Accredited by NAAC - UGC]
KOVAIPUDUR, COIMBATORE - 641042.

DEPARTMENT OF CIVIL ENGINEERING

 **INSTITUTION'S INNOVATION COUNCIL**
(Ministry of HRD Initiative)

Organizing a webinar on
IMPORTANT ASPECTS OF RCC STRUCTURE

Resource Person





























Er. A. KARTHIKEYAN
STRUCTURAL & GEOTECHNICAL CONSULTANT,
KARTHIKEYAN ASSOCIATES,
CHENNAI.

DATE 13.05.2020 **TIME** 3.00-4.00 PM



Close Participants (26)

Search

-  Selina Ruby G (me)   >
-  Mr. R. Ramesh Ass... (host)   >
-  KARTHIKEYAN   >
-  Mani's iPhone   >
-  18TUCV026 MANICK SI...   >
-  18tucv036 RAGHUL   >
-  19TPCV011 LOGESH.S   >
-  ABCDEFGHIJKLMNO...   >
-  Aravind TPA   >

Invite

Turn off Original Sound | You are viewing KARTHIKEYAN's screen | View Options

 KARTHIKEYAN

 Ms. S. Dharsana Asst...

 Thenappan M

 Dharshan.v

 18TUCV026 MANICK...

SANJAY

 Mr. R. Ramesh Asst Prof...

 KARAN P.

MUTHUKEERTH...

Aravind TPA

Realme 1

Lenin Sundar

Kavin

Madhu

Theena

 SREEVIDYA V

 Erainithi R

18tucv036

Mohith Krishna

Manojh kumar

 Selina Ruby G

Ms. A. Vennila

Connecting to audio ...

The Dept. of Civil Engineering organized a Webinar on “Important Aspects of RCC Structures” delivered by Er A Karthikeyan, Structural and Geotechnical Consultant, Karthikeyan Associates, Chennai on 13 May 2020. Students and the Members of Faculty in the Dept. of Civil Engineering attended the Webinar.

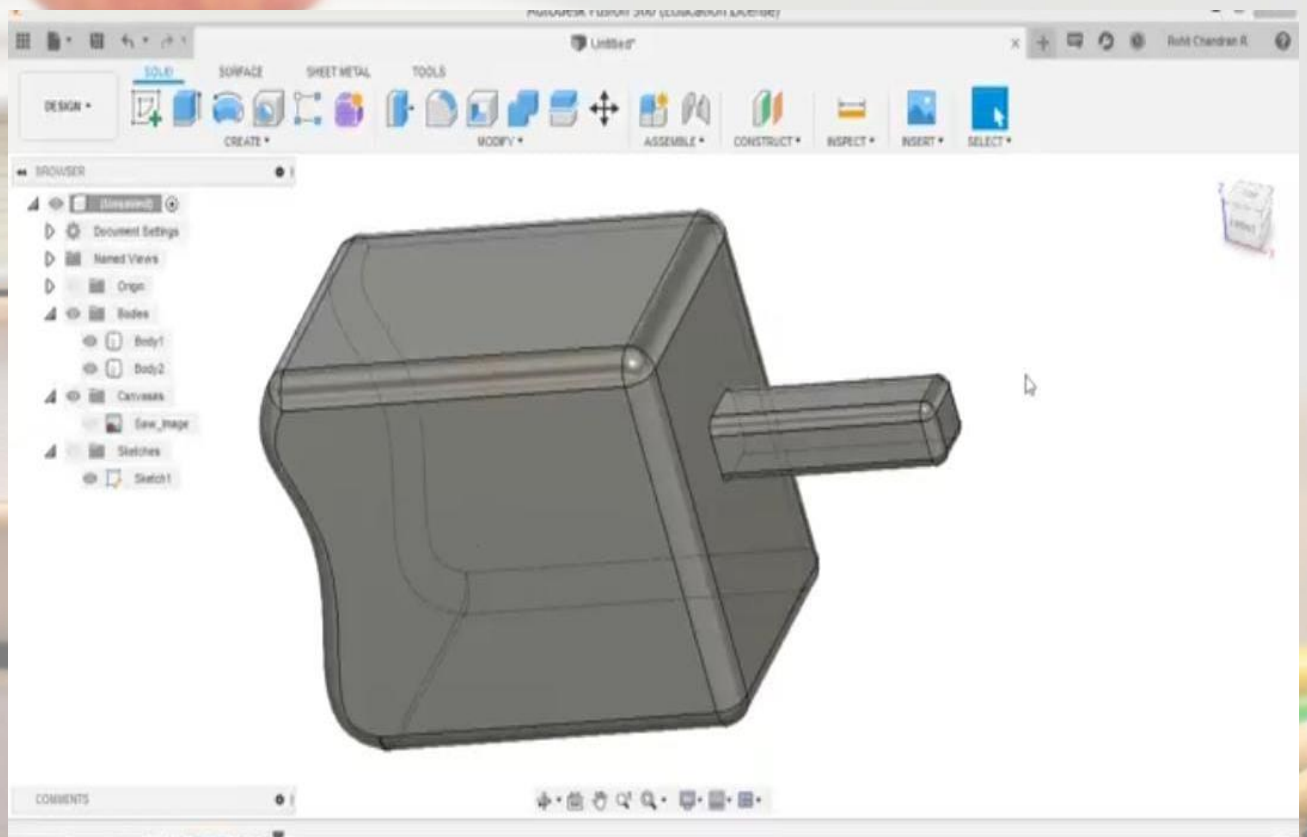
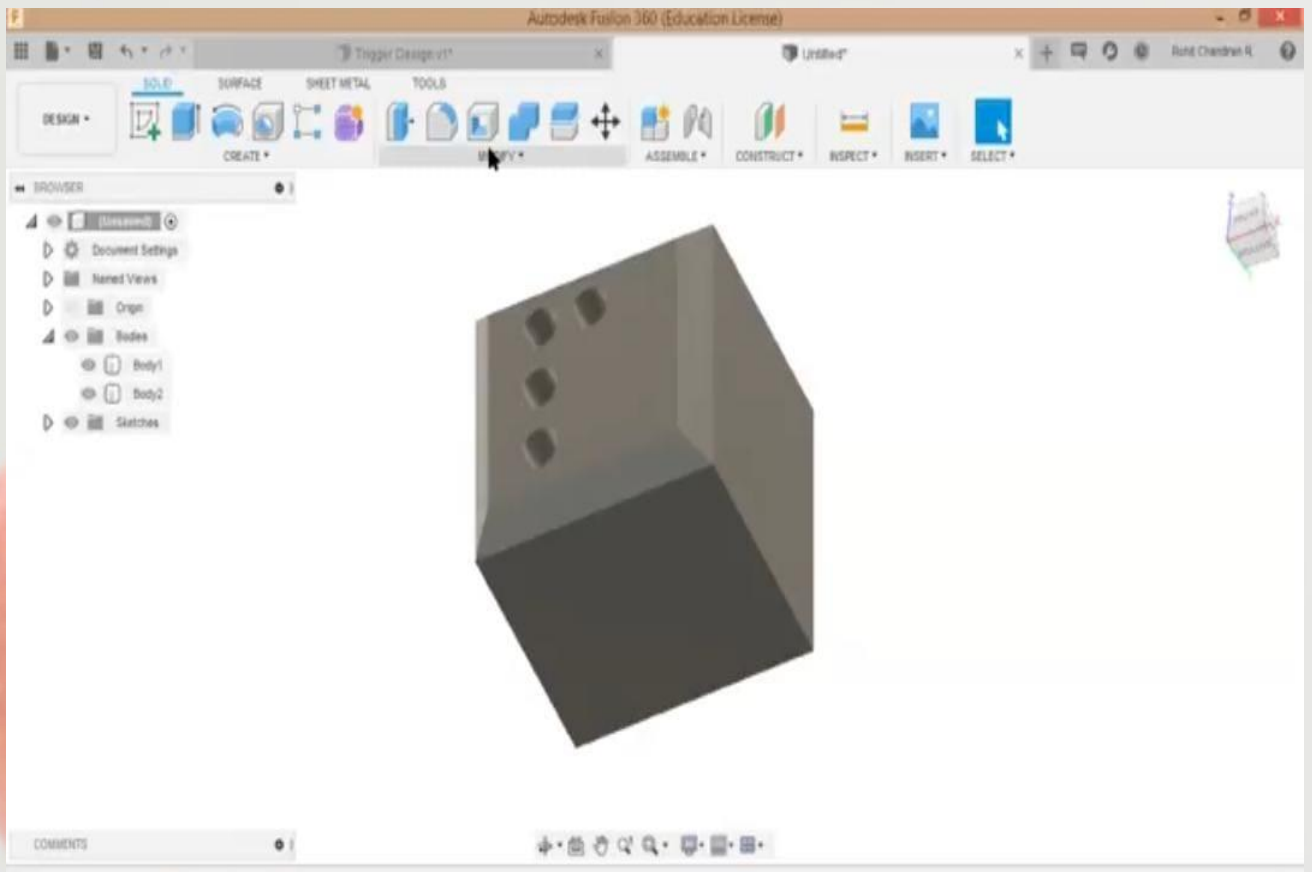

The Dept. of Mechanical Engineering organized a Webinar on “Autodesk Fusion 360” delivered by Auto Desk for the II B.E. Mechanical Engineering students on 13 May 2020.

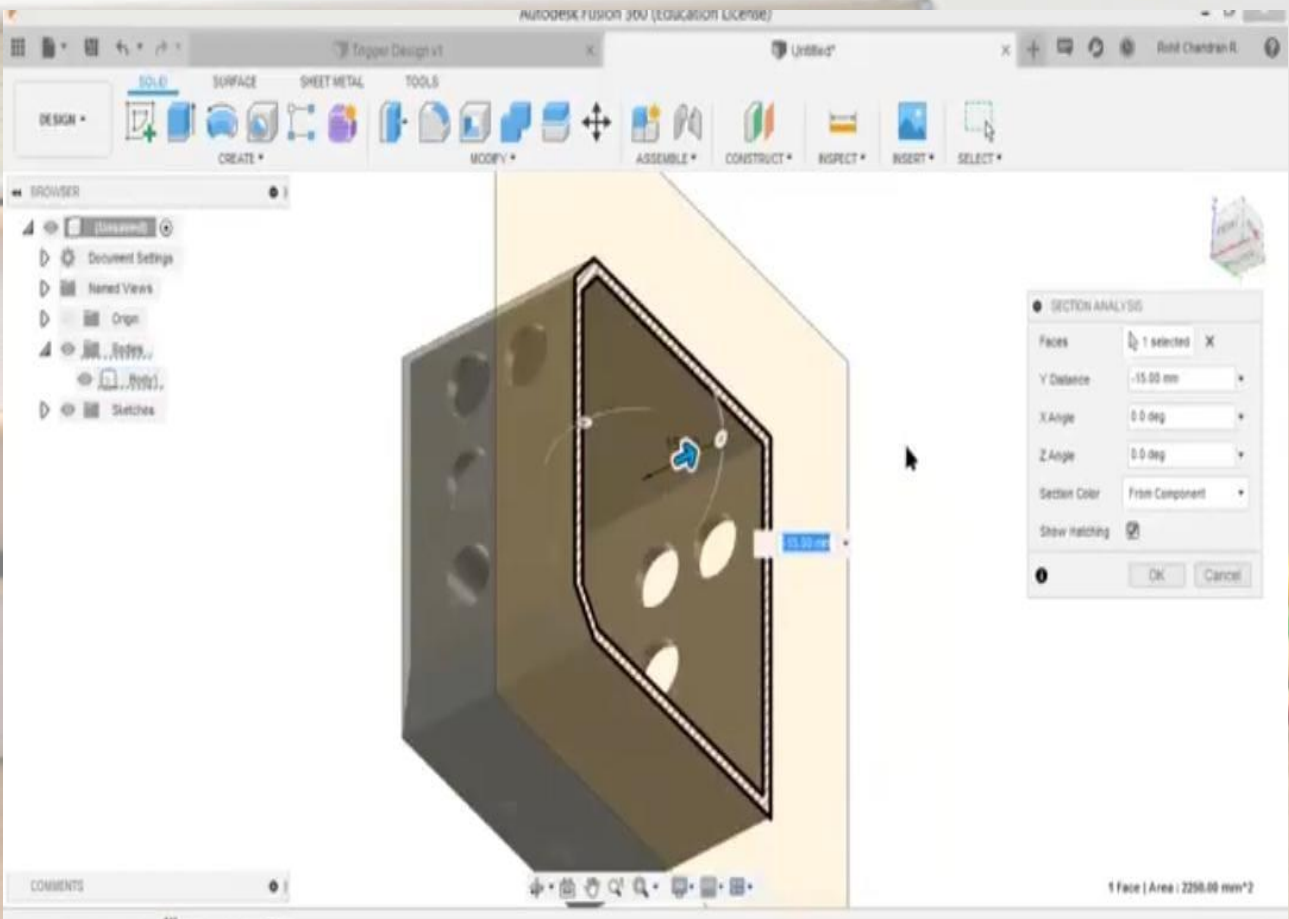
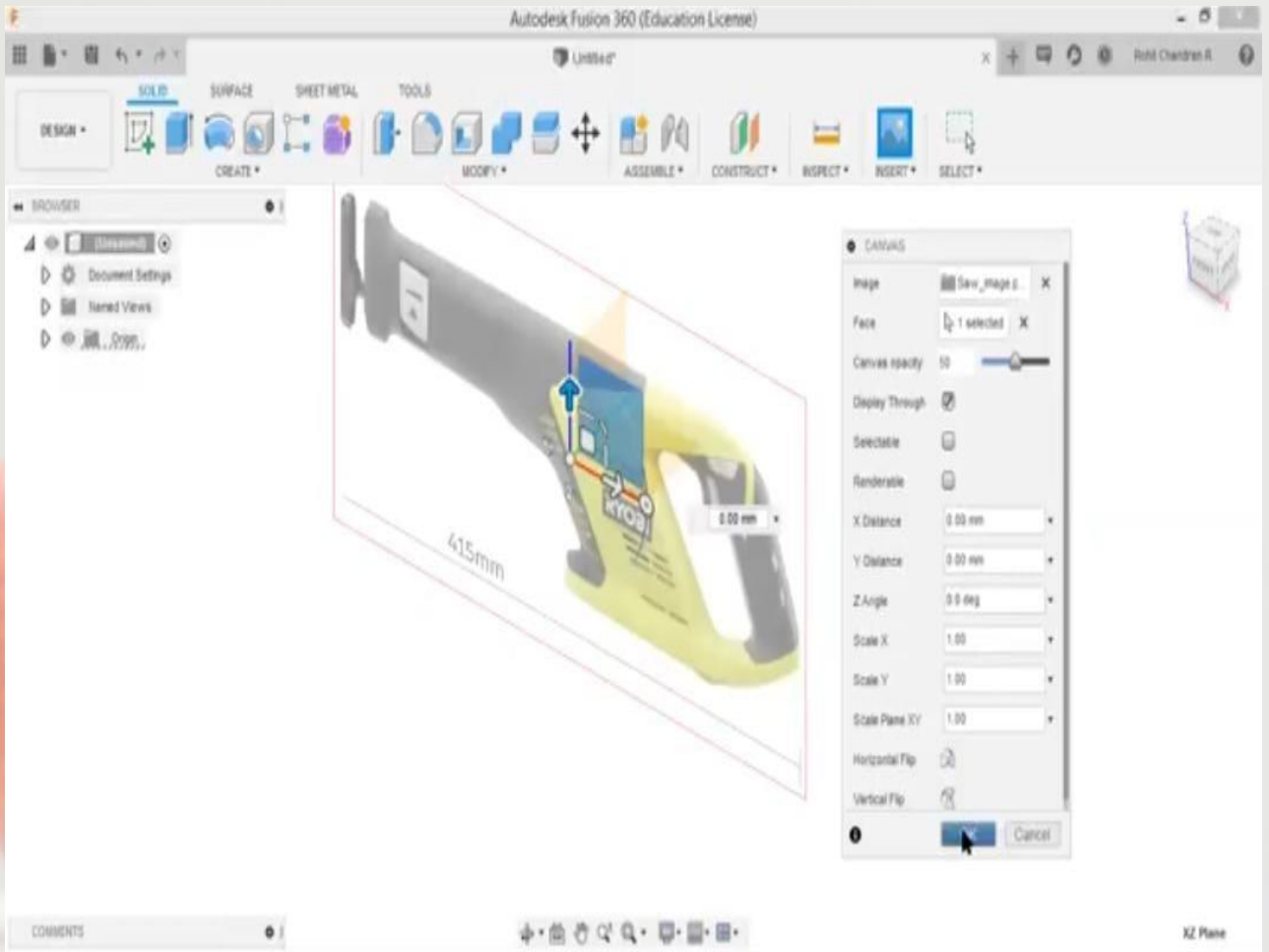

JOIN WEBINAR ON

Moisture Content determination by Hanna Karl Fischer Titration System

Learn the principles of Titration system, methods of titration and how Hanna Karl Fischer Titrator is an advantage for the industries.

Date : 14th May 2020 Time : 11 AM



What is Karl Fischer Titration?

Quantitative method for water determination

How much water does my material contain?

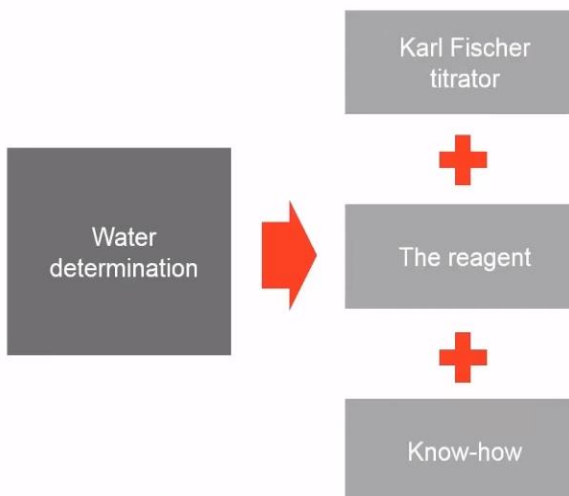

Volumetric and Coulometric
equipment provided by ES



Basic reagents needs
Vol.: titrating agent + solvent + standard
Coul.: reagent + standard

HYDRANAL®
Titrant (E)
white liq. Alcohol

HYDRANAL®
Composite
white liq. SO2, Puffer, DIBEE

HYDRANAL®
Solvent (E)
Solvent Oil
Solvent CM
SO2, Puffer, Alcohol

HYDRANAL®
Methanol Rapid
Methanol Dry
CompoSolvent E
Alcohol based liq.



Activate Windows
Go to PC settings to activate Windows.

Mr T P A Aravind, Asst. Professor, Dept. of Civil Engineering attended a Webinar on “Moisture Content Determination by Hnna Karl Fischer Titration System”, conducted by Hanna Instruments on 14 May 2020.

Certificate of Participation

This is to certify that

JAISHREE

has participated in the Webinar on
21st century communication skills powered by
Artificial Intelligence

presented by

Mr. Danish Dhamani, Mr. Kaushik Murali/ORAI

organised by **Chennai Institute of Technology**

on 08.05.2020.





Organizing Secretary

Convener

Principal

Ms M Jaishree, Asst. Professor; Dept. of ECE attended the Webinar on “21st Century Communication Skills Powered by Artificial Intelligence” conducted by Chennai Institute of Technology on 8 May 2020.

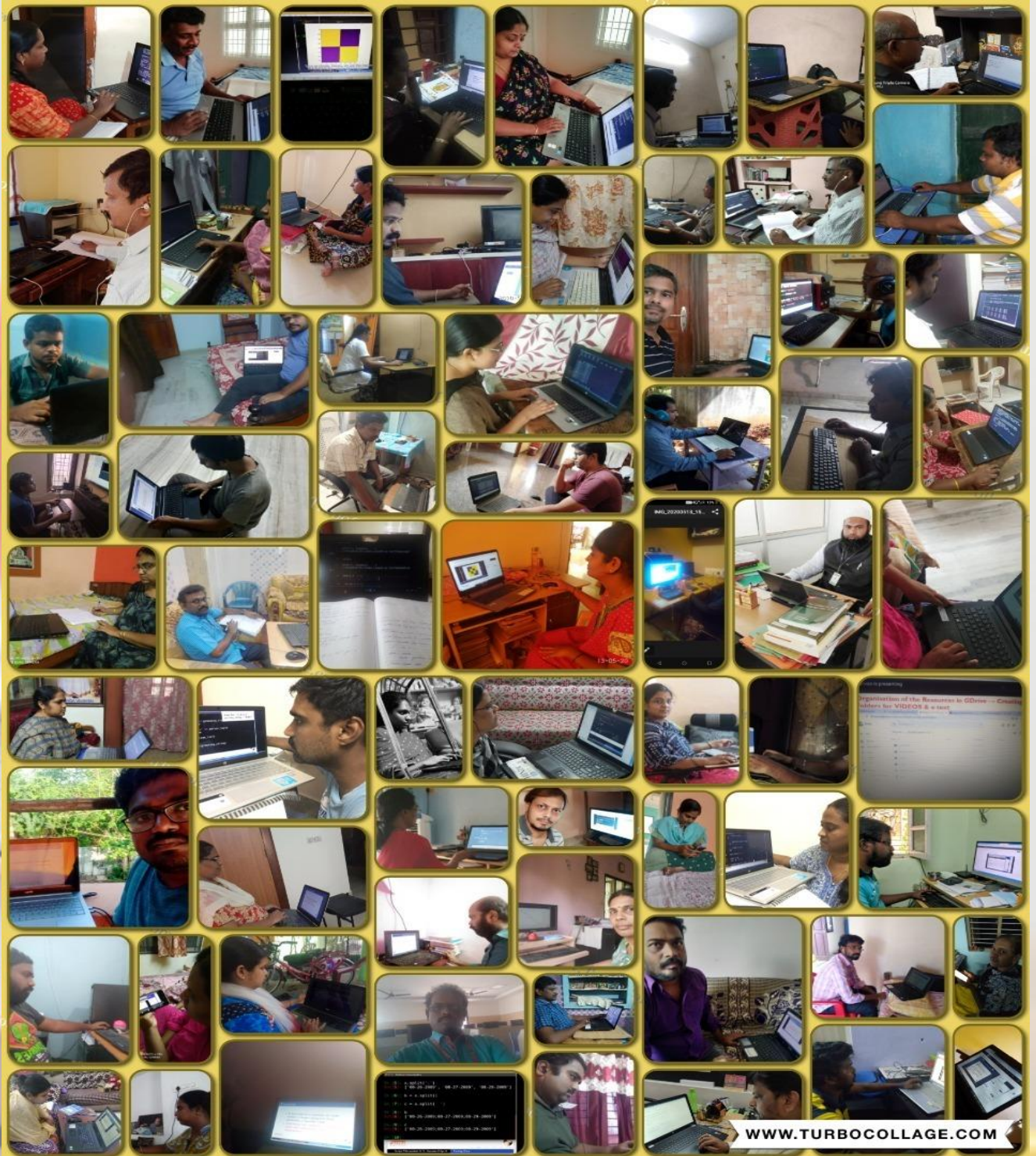
FDPs ORGANIZED



The Dept. of ECE and SKCT IITB Remote Centre organized the fifth day of the five-day Faculty Development Programme on "Python 3.4.3" in association with Spoken Tutorial-IITB on 14 May 2020. 160 Members of Faculty actively participated in the FDP. Dr R Udaiyakumar, Prof. & Head, Dept. of ECE and Mr S Ganesh Prabhu, Asst. Professor, Dept. of ECE coordinated the event.

OpenCV (*Open Source Computer Vision*)

- ... Library of classes and methods for real time computer vision algorithms
- ... Cross Platform FOSS written in C/C++
- ... More than 3500 Optimized Algorithms
- ... Primary Interface in C++
- ... Full Interfaces in Python, Java, MATLAB/Octave in form of APIs
- ... More than 14 Million Downloads
- ... More than 47,000 developers community

Ms P Anantha Prabha, Asst. Professor, Dept. of CSE attended the fourth day of the five-day short-term course on “**Neural Networks and CNN**” organised by NITTTR.

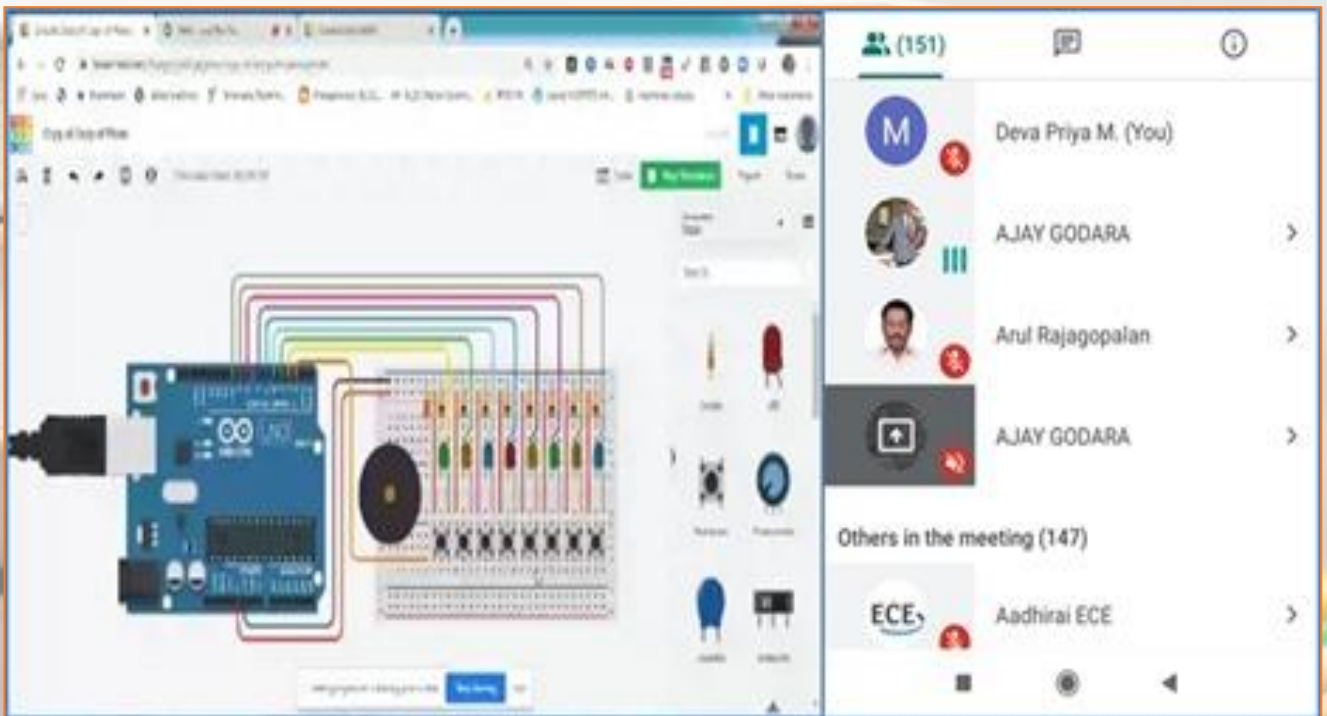

Dr M Deva Priya, Asso. Professor, Dept. of CSE attended the fourth day of the five-day Faculty Development Programme on “**Internet of Things**” organised by ATAL in association with Government College of Engineering, Srirangam, Trichy.

Ms S Sathya Bama and Ms G Priyanka, Asst. Professors, Dept. of CSE attended the fourth day of the five-day AICTE-ATAL Faculty Development Programme on “Data Science” organised by IIIT, Nagpur.

Few Questions

- What do we do with the *Data*?
 - Question Bank Analysis
 - Locating the Vikram Lander’s debris
 - Customer Profiling – Bank
 - Churn Prediction – Service Provider
- What is *DataOPS*?

Ms G Sandhya, Asst. Professor, Dept. of CSE attended the fourth day of the five-day AICTE-ATAL Faculty Development Programme on “Data Analytics Present & Future” organised by NIT Nagaland.

The screenshot shows a Zoom meeting interface. On the left, a presentation slide is displayed with the following content:

Care (ममता)	Guidance (वात्सल्य)
Feeling of responsibility toward the body of my relative	Feeling of responsibility toward the self of my relative
The responsibility & commitment for nurturing and protection of the Body of my relative	
संबंधी के शरीर के पोषण, संरक्षण की स्वीकृति का भाव।	
Care & Guidance are a natural outcome of Affection	

A chat window is open on the right side of the screen, showing a group chat with a context menu open over it. The menu options are: Group info, Select messages, Mute notifications, Clear messages, and Exit group. A message in the chat reads: "Day 3 Technical The ed by 9:57 AM". Another message below it says "ICTE-galand. am 9:59 AM".

At the bottom of the Zoom window, there is a notification from Dr. Jose K Jacob, Principal, Universal Engineering College, Thrissur to Everyone, with a "yes" response.

Ms A Sunitha Nandhini and Ms S Kiruthiga, Asst. Professors, Dept. of CSE attended the fourth day of the five-day Faculty Development Programme on **“Incorporating Human Values in Technical Education”** organised by ATAL/ AICTE in association with Anna University.

What is naïve Bayes?

- It is a probabilistic model used for function approximation problem.
- it works on probability theory.
- The idea is based on conditional probability and Bayes theorem
- It is called as naïve because it creates a model by assuming that all input variables are independent.

The screenshot shows a Zoom meeting interface. At the top, there is a toolbar with icons for mute, video, chat, and other functions. Below the toolbar, there is a row of participant icons with initials: BG, KM, VS, NC, DG, DA, SC, and KD. The names of the participants are listed below their icons: Dr. Navneet Agrawal, saswati chatterjee, and kudaravalli deepika. The background is a blurred presentation slide.

Ms M Kavitha Margret, Asst. Professor, Dept. of CSE attended the fourth day of the five-day Faculty Development Programme on **“Artificial Intelligence”** organised by ATAL/AICTE.

CISCO Webex

Home Webex Meetings Webex Events Webex Support Webex Training My Webex Modern View **NEW**

Attend a Session

- Host a Session
- Set Up
 - Webex Training
 - Preferences
- Support

Session Information: Data Science using R

English : Mumbai T

Session status: Not Started

Session date: Thursday, May 14, 2020

Starting time: 11:30 am, India Time (Mumbai, GMT+05:30)

Duration: 6 hours

Presenters: fdp1 fdp1

Description: Predictive Analytics using R and logistic regression, hypothesis testing

Agenda: Predictive Analytics using R and logistic regression, hypothesis testing

Session number: 918 616 396

Password: Please obtain your session password from your host.

Audio conference: To receive a call back, provide your phone number when you join the training session, or call the number below and enter the access code.
Singapore Toll:+65-6703-6949

Having trouble dialing in? Try these backup numbers:
Singapore Toll:+65-6703-6949
[Show all global call-in numbers](#)
Access code: 918 616 396

Host's name: fdp1 fdp1
Host's email: fdp1@nitttrchd.ac.in
Course material: (none)

Join Session Now

You cannot join the training session now because it has not started.

Your name:

Email address:

Session password:

[Join by browser](#) **NEW!**

If you are the host, [start your session](#).

Ms Viraja Ravi, Asst. Professor, Dept. of CSE attended the fourth day of the five-day Faculty Development Programme on "**Data Science Using R**" organised by NITTTR, Chandigarh.

File Edit View Format Project Tools Options Window Help

md5.php

```

5 . 10 . 15 . 20 . 25 . 30 . 35 . 40 . 45 . 50 . 55 . 60 . 65

if ($_POST['password'])
{

    $submittedenc = md5($_POST['password']);

    if ($submittedenc==$userpasswordenc)
        echo "Compared $userpasswordenc to".$submittedenc;
        die("Correct");
    else
        die("Incorrect");
}

```

Ln 13, Col 51 Insert Set Normal

phpacademy

Ms N R P Nivetha, Asst. Professor, Dept. of CSE attended the fourth day of the five-day Faculty Development Programme on "**PHP and MySQL**" organised by VIT, Chennai in association with Spoken Tutorial, IIT Bombay.

FDPs ATTENDED

You are viewing Sukhdeep S. Dhami's desktop

Mathematical Model of System

$$M \frac{d^2x}{dt^2} + D \frac{dx}{dt} + Kx = F(t) \quad \text{----- (1)}$$

Denoting $\frac{dx}{dt}$ as \dot{x} , $\frac{d^2x}{dt^2}$ as \ddot{x}

Equation (1) may be written as

$$M\ddot{x} + D\dot{x} + Kx = F(t) \quad \text{----- (2)}$$

or $\ddot{x} = \frac{F(t) - Kx - D\dot{x}}{M} \quad \text{----- (3)}$

Sukhdeep S. Dhami

1 hr 05 min to full charge

You are viewing Sukhdeep S. Dhami's desktop

Building Simulink Model of System

$$\ddot{x} = \frac{F(t) - Kx - D\dot{x}}{M}$$

Sukhdeep S. Dhami

11:41

Dr P Santhosh, Asst. Professor, Dept. of EEE attended the fourth day of the five-day short-term Course on “MATLAB Programming” presented by Dr S S Dhami, Professor, Dept. of Mechanical Engineering, NITTTR, Chandigarh on 14 May 2020.

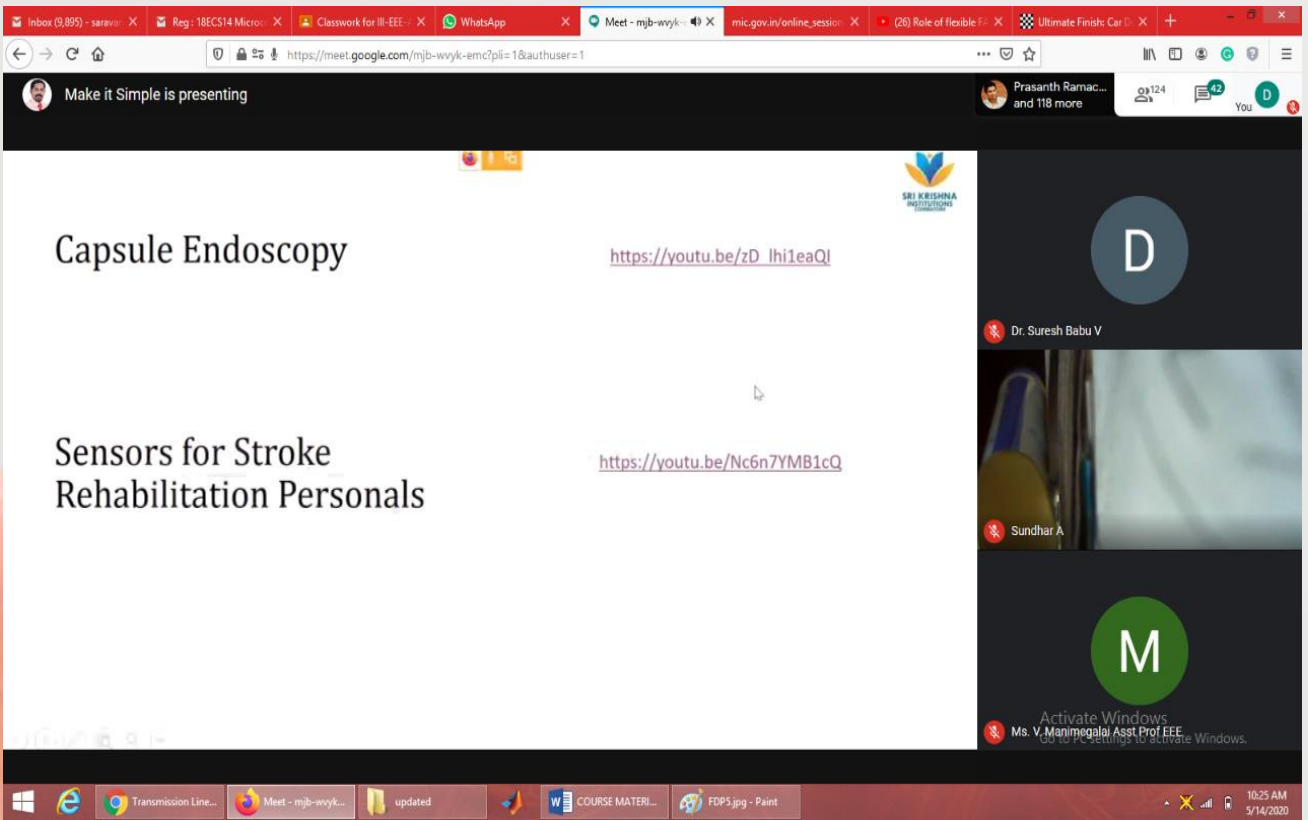

Members of Faculty, Dept. of EEE attended the fourth day of the five-day Faculty Development Programme on **“IoT for Bio-Medical Applications”** organized by the Dept. of Electronics and Communication Engineering, Hindusthan Institute of Technology, Coimbatore on 14 May 2020. Dr P Santhosh, Asst. Professor, Dept. of EEE coordinated the event.

Multi-layer back-propagation neural network

The diagram illustrates a neural network with three layers: an input layer with nodes x_1, x_2, \dots, x_n ; a hidden layer with nodes z_1, z_2, \dots, z_m ; and an output layer with nodes y_1, y_2, \dots, y_k . Weights w_{ij} connect nodes between layers. A blue arrow labeled "input signals" points from left to right, and another labeled "Error signals" points from right to left.

Video call interface showing a participant named fdp8 fdp8 (host).

Variable declarations:

Name	Value
input	6x15 double
targetclass	1x15 double
testingForPrediction	6x6 double

Table with 10 columns and 10 rows of numerical data.

Video call interface showing a participant named Speaking: Gaurav Kumar.

OpenCV Python

Digital Image / Video Processing

Contents

- Key Features of OpenCV Library
- Accessing WebCam using OpenCV
- Image Feature Extraction using OpenCV
- Training Features in ANN using Python
- Classification Reports and Predictions

Video call interface showing a participant named Gaurav Kumar.

OpenCV (Open Source Computer Vision)

- ... Library of classes and methods for real time computer vision algorithms
- ... Cross Platform FOSS written in C/C++
- ... More than 3500 Optimized Algorithms
- ... Primary Interface in C++
- ... Full Interfaces in Python, Java, MATLAB/Octave in form of APIs
- ... More than 14 Million Downloads
- ... More than 47,000 developers community

GK logo

Video call interface showing a participant named Gaurav Kumar.

Mr A Suresh Kumar and Ms M Malathi, Asst. Professors, Dept. of IT attended the fourth day of the five-day Online Faculty Development Programme on “**Neural Network and Convolution Network**” organized by NITTTR on 14 May 2020.

Perceptron

A single Neuron in Neural Network is known as Perceptron

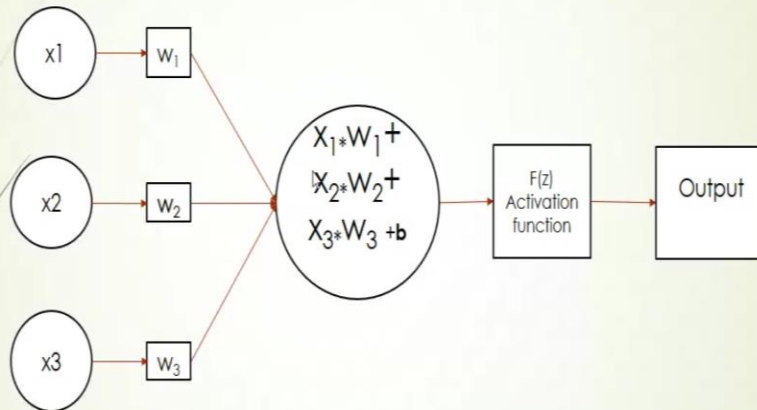

meet.google.com is sharing your screen. Stop sharing Hide

2. Tanh or hyperbolic tangent Activation Function

Range : (-1 to 1)

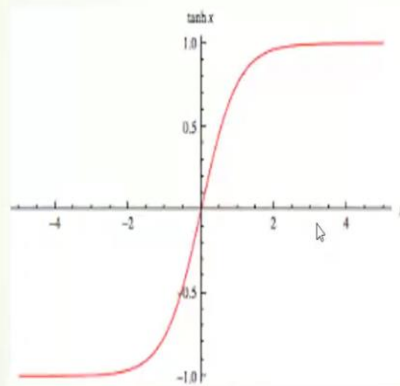

meet.google.com is sharing your screen. Stop sharing Hide

Ms S Madumidha, Asst. Professor, Dept. of IT attended the fourth day of the five-day AICTE Training and Learning (ATAL) Program for Faculty Development on "Artificial Intelligence (AI)", organized by the Dept. of Electronics and Communication Engineering, U.I.E.T, Kurukshetra University, Kurukshetra on 14 May 2020.

Types of Variables

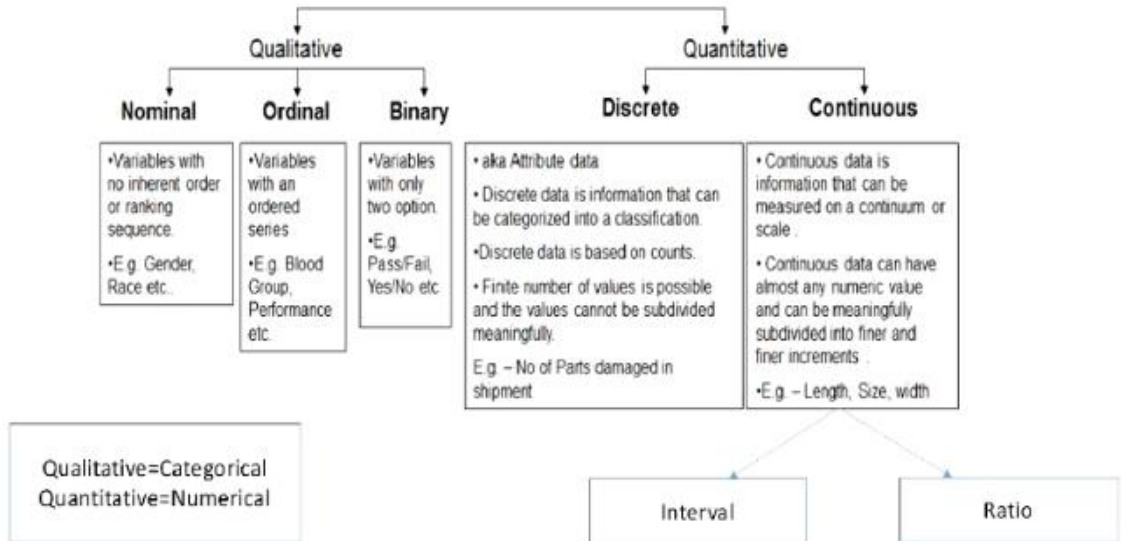

Dr.Pooja Jain, IIITM

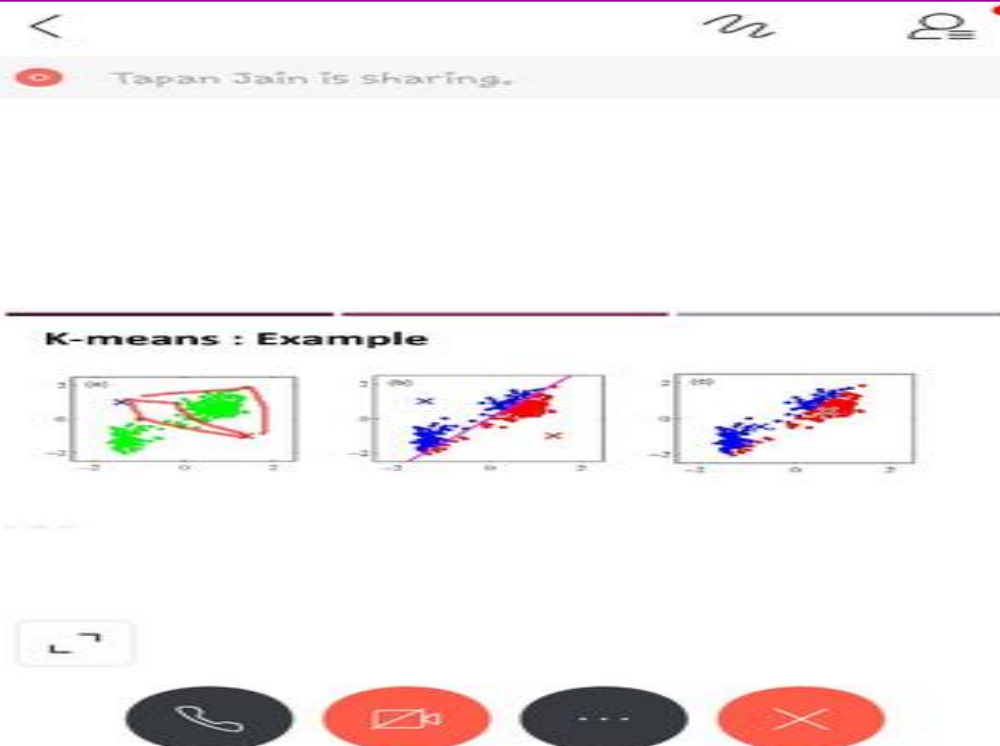

Ms S Muthulakshmi, Asst. Professor, Dept. of IT attended the fourth day of the five-day AICTE Training and Learning (ATAL) Program for Faculty Development on “Data Science”, organized by IIIT Nagpur on 14 May 2020.



https://www.researchgate.net/figure/Built-in-sensors-in-a-typical-present-day-smartphone_fig2_332973899

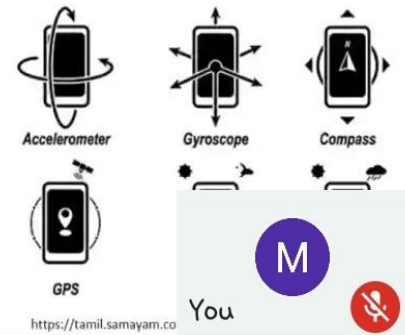

<https://tamil.samayam.co>



Pulse Diagnosis

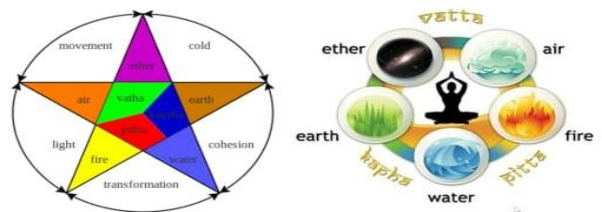

(122) 31

- Ms. M.Jaishree ASST. PROF (You)
- Make it Simple
- Dr. Suresh Babu V
- Make it Simple

Others in the meeting (118)

(122) 32

- Ms. M.Jaishree ASST. PROF (You)
- Make it Simple
- Dr. Suresh Babu V
- Make it Simple

Others in the meeting (118)

Ms M Jaishree and Ms S Thenmozhi, Asst. Professors, Dept. of ECE attended the fourth day of the five-day Faculty Development Programme on **“IoT Trends to Drive Innovation for Businesses and Digital Technology”** conducted by Hindustan Institute of Technology on 14 May 2020.

Design Considerations

- **Sensor Characteristics:** *Resolution/Time Response*
- **Actuation Mechanism:** *Degrees of freedom/Torque requirement*
- **Embedded System Platform Selection:** *Sampling Rates/ADC Resolution*

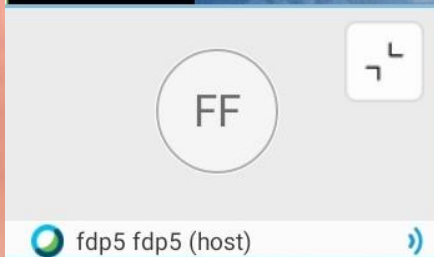

Embedded System V/S The Complete System

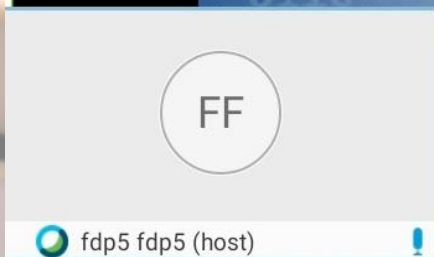
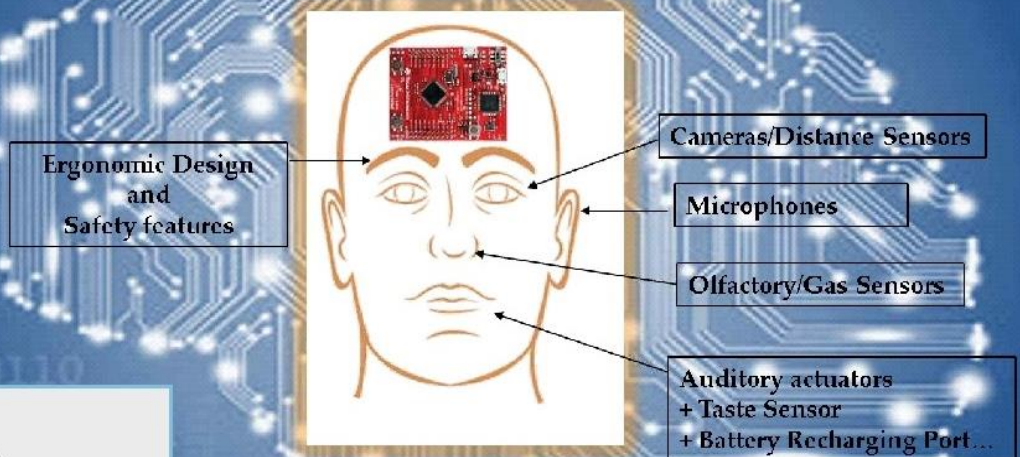

Ms E L Dhivya Priya, Asst. Professor; Dept. of ECE attended the fourth day of the five-day Faculty Development Programme on “Image and Embedded Processing” organized by NITTTR Chandigarh on 14 May 2020 .

Harmony in Family – Justice, From Family to World Family (Undivided Society)

1. Relationship is – between one self (I_1) and other self (I_2)
2. There are feelings in relationship – in one self (I_1) for other self (I_2)
3. These feelings can be recognized – they are definite (9 Feelings)
4. Their fulfilment, evaluation leads to mutual happiness

Feelings in relationship:

- | | |
|--|-------------------------------------|
| 1. Trust विश्वास FOUNDATION VALUE | 6. Reverence श्रद्धा |
| 2. Respect सम्मान | 7. Glory गौरव |
| 3. Affection स्नेह | 8. Gratitude कृतज्ञता |
| 4. Care ममता | 9. Love प्रेम COMPLETE VALUE |
| 5. Guidance वात्सल्य | |

Justice = Recognition, Fulfillment & Evaluation of Human-Human Relationship, leading to Mutual Happiness

Justice → from Family to World Family → Undivided Society (अखण्ड समाज)

24

Preconditioning Related to Love

This is certainly not Love!

The feeling of love needs to be understood rightly by all, particularly by youth

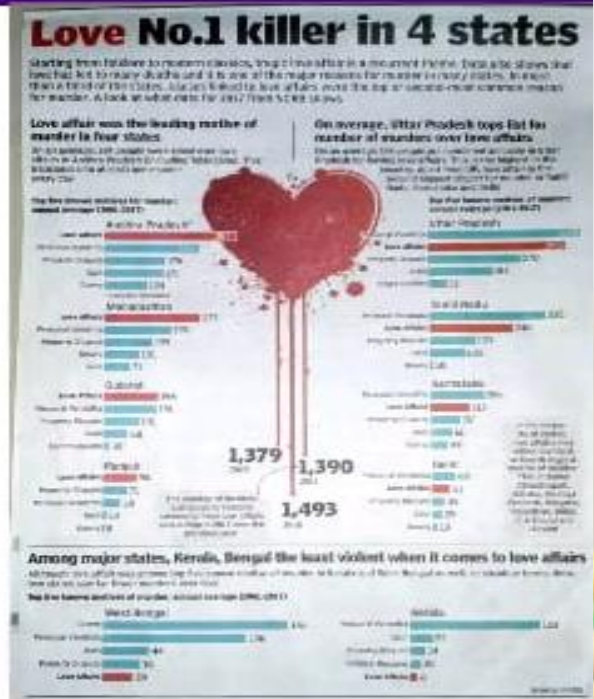

25

Members of Faculty, Dept. of Mechanical Engineering attended the fourth day of the five-day Workshop on "Incorporating Universal Human Values in Technical Education" - an AICTE Initiative on 14 May 2020.

TALK SERIES

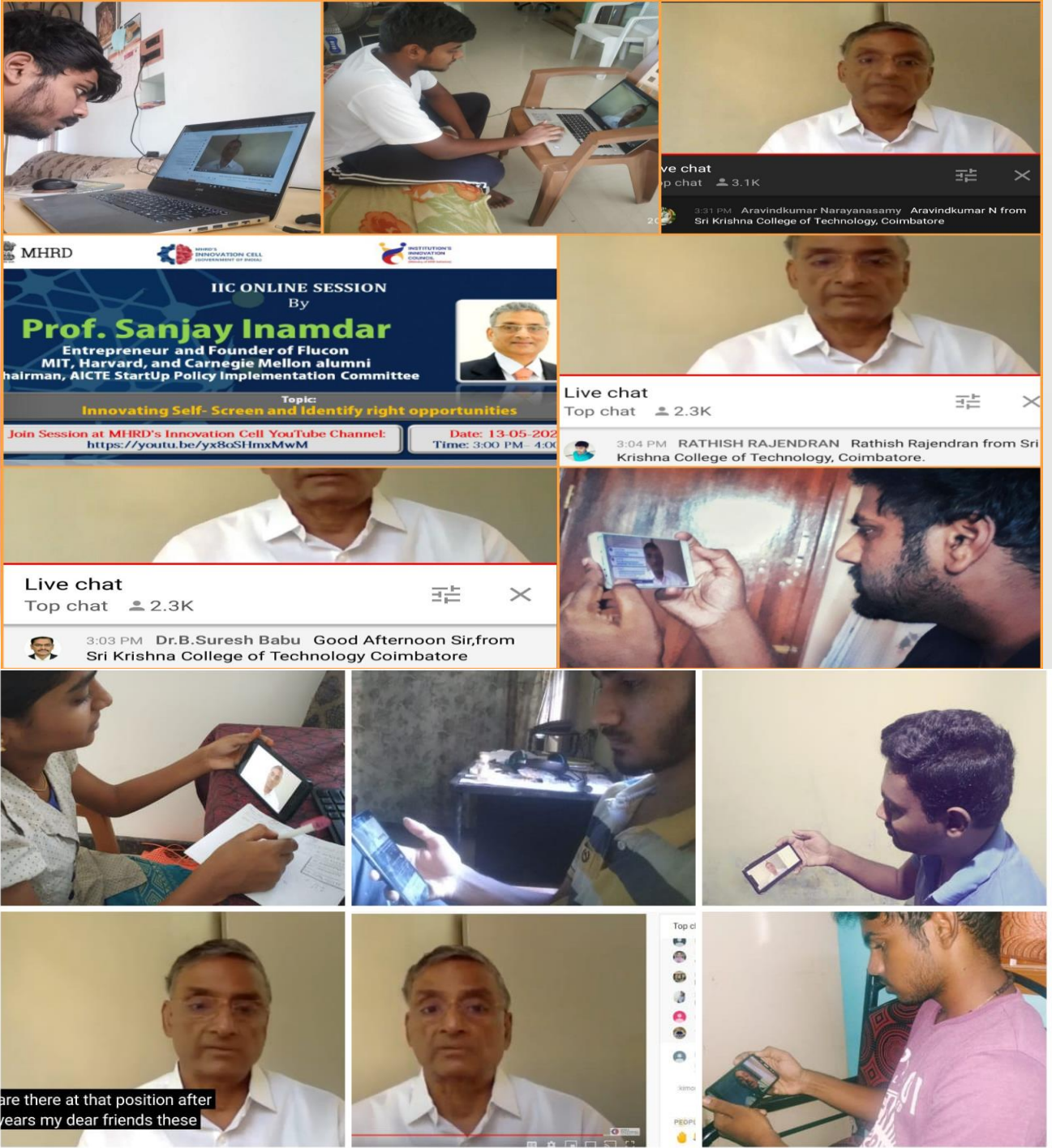

Dr Srinivasan Alavandar, Principal, Heads of the Departments, Members of Faculty and Students of Sri Krishna College of Technology, Coimbatore attended the Online Session on **“Innovating Self-Screen and Identify Right Opportunities”** conducted by Prof. Sanjay Inamdar, Entrepreneur and Founder of Flucon MIT, Harvard, and Chairman of the Carnegie Mellon Alumni, AICTE StartUp Policy Implementation Committee on 13 May 2020. Ms V Roopa, Asst. Professor, Dept. of IT coordinated the session.

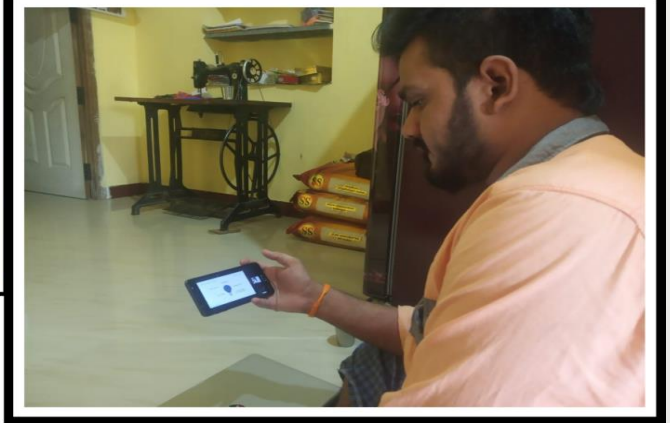
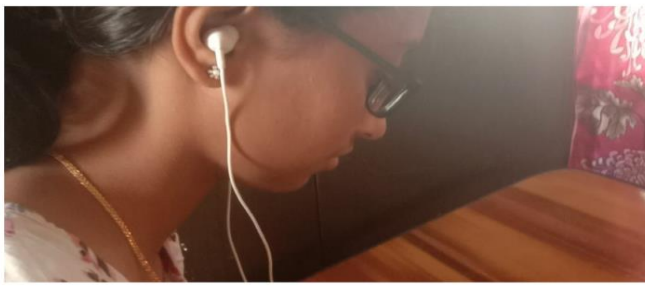

MHRD  INSTITUTIONS' INNOVATION COUNCIL

IIC ONLINE SESSION
By
Prof. Sanjay Inamdar
Entrepreneur and Founder of Flucon
MIT, Harvard, and Carnegie Mellon alumni
Chairman, AICTE StartUp Policy Implementation Committee

Topic:
Innovating Self- Screen and Identify right opportunities

Join Session at MHRD's Innovation Cell YouTube Channel:
<https://youtu.be/yx8oSHmxMwM>

Date: 13-05-20
Time: 3:00 PM - 4:00



 MHRD Innovation Cell
34K subscribers

Premiere in progress. Started 18 minutes ago
Topic:
Innovating Self- Screen and Identify right opportunities

MHRD  INSTITUTIONS' INNOVATION COUNCIL

IIC ONLINE SESSION
By
Prof. Sanjay Inamdar
Entrepreneur and Founder of Flucon
MIT, Harvard, and Carnegie Mellon alumni
Chairman, AICTE StartUp Policy Implementation Committee

Topic:
Innovating Self- Screen and Identify right opportunities

Join Session at MHRD's Innovation Cell YouTube Channel:
<https://youtu.be/yx8oSHmxMwM>

Date: 13-05-2020
Time: 3:00 PM - 4:00 PM



Screen and Identify right opportunities: 13th May 2020, Time 03.00 PM to 04.00 PM (Last Date for Submission:19th May 2020)



Research Ethics_Revised - PowerPoint

File Home Insert Design Transitions Animations Slide Show Review View Help Search

Ensuring ethical research: Acquisition of samples

- Non-biological samples
 - Physical sciences
 - Analytical sciences (Financial, economic, demographic, etc.)
 - Social sciences – samples from observation of human life/ activity
 - Samples from the Internet
 - Samples from existing documents/ literature
- Biological Samples
 - Human
 - Animal
 - Plant
 - Micro-organisms
- Dead samples

NPTEL SPECIAL LECTURE SERIES

Notes Comments

61%

Research Ethics_Revised - PowerPoint

File Home Insert Design Transitions Animations Slide Show Review View Help Search

Acquisition and usage of dead human samples

- Just died
 - Family must be treated as discussed in the previous slide
- Unclaimed cadavers and donations of cadavers
 - Legal compliance in acquisition
 - Standard operating procedures
 - Minimization of wastage and appropriate disposal
- Exhumation of geological samples: Ref: Virtual tour of the Museum of Medical Oddities
<https://www.youtube.com/watch?v=dqj2fk29NZA>

NPTEL SPECIAL LECTURE SERIES

Notes Comments

61%

Live_Research Ethics

581 watching now

76 members of faculty and 294 students of SKCT attended the NPTEL Lecture Series on “Research Ethics” with Dr Aradhna Malik, Professor, IIT, Kharagpur on 13 May 2020. Mr S Ganesh Prabhu, Asst. Professor, Dept. of ECE coordinated the event.

STUDENTS' PARTICIPATION

BINGO! You have been selected
as a Skillenza Hustler 🚀 Inbox



Prakarsh Pathak 7:59 pm
to me ▾



Hey Deepthi Shree S,

We hope you are doing well during the COVID-19 Pandemic. While the whole nation is on lockdown, we are excited to cheer you up a little.

Congratulations! We have reviewed your profile, and we are excited to have you on-board for the "Skillenza Campus Ambassador Program". We look forward to working with you and creating an impact in the student developer ecosystem PAN India.

Skillenza Team will guide you throughout your Virtual Internship. So, Get ready to become a part of India's largest developer platform, Skillenza.

Ms S Deepthi Shree of II B.E CSE A Section has been selected as **Skillenza Campus Ambassador.**



A.V.C. COLLEGE OF ENGINEERING
Approved by AICTE, Affiliated to Anna University
Re-Accredited by NAAC with 'B++' Grade(2nd Cycle)
An ISO 9001:2015 Certified Institution



44 years of excellence in technical education

BIO INDIA

GREEN INDIA

Certificate of Appreciation

This is to certify that **SUJAN KARTHI N**, 1 ST YEAR, INFORMATION TECHNOLOGY has successfully completed the Online Quiz Program entitled HTML on 14-5-2020 conducted by Department of Information Technology with passing score of **85%**.



XDOXAQ-CE002621



A.V.C. COLLEGE OF ENGINEERING
Approved by AICTE, Affiliated to Anna University
Re-Accredited by NAAC with 'B++' Grade(2nd Cycle)
An ISO 9001:2015 Certified Institution



44 years of excellence in technical education

BIO INDIA

GREEN INDIA

Certificate of Appreciation

This is to certify that **SUDHAGAR M**, I year, INFORMATION TECHNOLOGY has successfully completed the Online Quiz Program entitled HTML on 14-5-2020 conducted by Department of Information Technology with passing score of **95%**.



XDOXAQ-CE002662

Mr N Sujan Karthi and Mr M Sudhagar of I B.Tech. IT B Section completed the "HTML Online Quiz Program" conducted by the Department of Information Technology, A. V. C. College of Engineering, Mayiladuthurai on 14 May 2020 and received the Certificates of Appreciation.

FACULTY PARTICIPATION

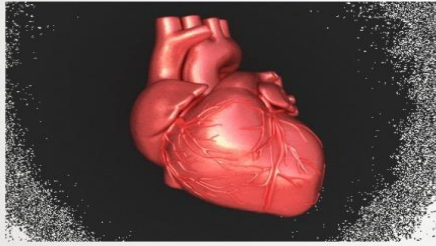

Thank U..



https://www.researchgate.net/figure/Built-in-sensors-in-a-typical-present-day-smartphone_fig2_332973899

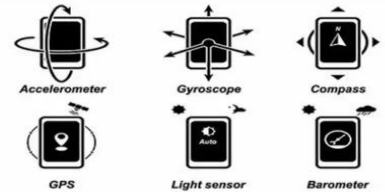

<https://tamil.samayam.com/tech/news/smartphone-sensors-and-their-uses-working-principle/articleshow/68450002.cms>

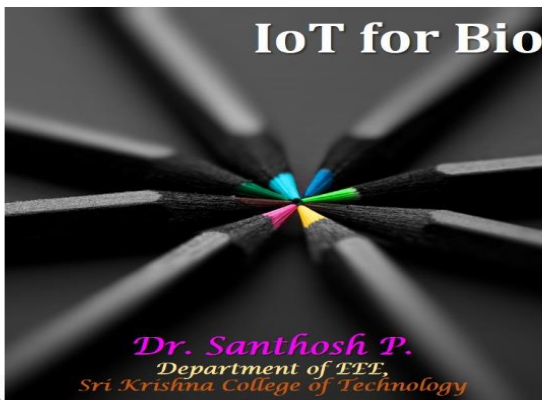

IoT for Bio Medical Applications



Dr P Santhosh, Asst. Professor, Dept. of EEE was invited as a Resource Person for the Day 4 Session and delivered a talk on "IoT for Bio-Medical Applications" in the five-day FDP on "IoT Trends to Drive Innovation for Business and Digital Technology" conducted by Hindusthan Institute of Technology, Coimbatore on 14 May 2020.

Reference Number: GGI/MIC/2020/11772

CERTIFICATE OF MERIT



This is to certify that
Dr. P PONMURUGAN

From

Sri Krishna College of Technology, Coimbatore

Has actively participated and secured

All India Rank: 2

In online quiz competition on and
Leadership Talk Series: Learn from Leaders
With

Held on
May, 2020

Organized By
MHRD's Institution Innovation Council
Gulzar Group of Institutes, Ludhiana

Convener

Director

Dr P Ponnurugan, Asst. Professor, Dept. of EEE has been certified for having participated and secured the All India Rank 2 in the “**Online Quiz Competition and Leadership Talk Series: Learn from Leaders**” organized by MHRD ‘s Institution Innovation Council, Gulzar Group of institutes, Ludhiana held in May 2020.

simplilearn

Certificate of Achievement

Congratulations!

Ms.T.Suganya

You have successfully completed our training program on
Introduction to IOT

14th May 2020
Certificate code : 1879642



Krishna Kumar
CEO

Ms T Suganya, Asst. Professor, Dept. of CSE completed a certification on “**Introduction to IOT**” offered by Simplilearn.



Government of India
Ministry of Human Resource
Development

*Teaching Learning Centre
Ramanujan College
University of Delhi*

Sponsored by
MINISTRY OF HUMAN RESOURCE DEVELOPMENT
PANDIT MADAN MOHAN MALAVIYA
NATIONAL MISSION ON TEACHERS AND TEACHING

Certificate

This is to certify that

Dr.P.Pandiyan

of

Sri Krishna College of Technology, Coimbatore-42.

participated in Two Weeks Faculty Development Programme on
"MANAGING ONLINE CLASSES and CO-CREATING MOOCS"
from April 20 - May 06, 2020.



DR. S.P. AGGARWAL
(Principal)
Director, TLC
Ramanujan College

DR. NIKHIL RAJPUT
(Convenor)
Assitant Director, TLC
Ramanujan College

Dr P Pandiyan, Asst. Professor, Dept. of EEE has been certified for having successfully attended the two-week FDP on **"Managing Online Classes and Co-Creating MOOCS"** from 20 April 2020 to 06 May 2020 sponsored by Ministry of Human Resource Development, Pandit Madan Mohan Malaviya National Mission on Teachers and Teaching..



"Dissemination of education for Knowledge, Science and Culture"
-Shikshanmaharshi Dr. Bapuji Salunkhe

Shri Swami Vivekanand Shikshan Sanstha's

Vivekanand College (Autonomous), Kolhapur

NAAC Reaccredited : "A" (CGPA 3.24)
College with Potential for Excellence (Twice)
"Star College" by D.B.T. Govt. of India

IQAC & Department of Computer Science organized
in association with Spoken Tutorial - IIT Bombay
(Funded by MHRD, Government of India)



Spoken Tutorial -
IIT Bombay

One Week Faculty Development Program on "MOODLE Learning and Management System"

Certificate

This is proudly awarded to
Jeyabharathi D

for successful completion of One Week Faculty Development Program on "MOODLE Learning and Management System" organized by Internal Quality Assurance Cell (IQAC) and Department of Computer Science through online mode during 25-30 April 2020.

Dr. V. B. Waghmare
Co-ordinator

Ms. R. Y. Patil
Co-ordinator

Dr. Kailas Patil
IQAC Co-ordinator

Dr. S. Y. Hongekar
Principal

Certificate ID: VIZFOU-CE000397

Dr D Jeyabharathi, Asst. Professor, Dept. of IT successfully completed the one-week Faculty Development Program on "MOODLE Learning and Management System" organized by the Internal Quality Assurance Cell and Dept. of CS through online mode during 25 -30 April 2020.



A.V.C. COLLEGE OF ENGINEERING
Approved by AICTE, Affiliated to Anna University
Re-Accredited by NAAC with 'B++' Grade(2nd Cycle)
An ISO 9001:2015 Certified Institution



24 years of excellence in technical education

BIO INDIA

GREEN INDIA

Certificate of Appreciation

This is to certify that **Jeyabharathi D**, Assistant professor , information Technology has successfully completed the **Online Quiz Program** entitled **HTML** on **14-5-2020** conducted by **Department of Information Technology** with passing score of **100%**.



XDOXAQ-CE002585

Dr D Jeyabharathi, Asst. Professor, Dept. of IT successfully completed the **Online Quiz Program** titled HTML on 14 May 2020.



ALL INDIA COUNCIL FOR TECHNICAL EDUCATION
Nelson Mandela Marg, Vasant Kunj, New Delhi – 110 070

AICTE Training And Learning (ATAL) Academy

Certificate

This to be certified that **RAGHUNATHAN T** participated & completed successfully AICTE Training And Learning (ATAL) Academy Online FDP on "Data Sciences" from 20-04-2020 to 24-04-2020 at **MSME - TECHNOLOGY DEVELOPMENT CENTRE (PPDC) Meerut.**

Director ATAL Academies



Coordinator



ALL INDIA COUNCIL FOR TECHNICAL EDUCATION
Nelson Mandela Marg, Vasant Kunj, New Delhi – 110 070

AICTE Training And Learning (ATAL) Academy

Certificate

This to be certified that **NIVETHA NRP** participated & completed successfully AICTE Training And Learning (ATAL) Academy Online FDP on "Data Sciences" from 20-04-2020 to 24-04-2020 at **MSME - TECHNOLOGY DEVELOPMENT CENTRE (PPDC) Meerut.**

Director ATAL Academies



Coordinator

Ms B Dhanalakshmi and Ms N R P Nivetha, Asst. Professors, Dept. of CSE participated in the five-day Online Faculty Development Programme on "Data Science" organised by ATAL Academy.

Opposition, Affection and Love

Verify on the basis of your natural acceptance if you want to be related to:

- | | | |
|------------|---|-------------|
| ✗ None | → The feeling of being related to none – in opposition to all | } Affection |
| ✓ One | → The feeling of being related to one | |
| ✓ Many | → The feeling of being related to many | |
| ✓ Everyone | → The feeling of being related to all | } Love |

Affection (स्नेह) – The feeling of being related to the other
(acceptance of the other as one's relative)
दूसरे को संबंधी के रूप में स्वीकारने का भाव।

Love (प्रेम) – The feeling of being related to all (Complete Value)
= हर एक को संबंधी के रूप में स्वीकारने का भाव।



Chat



Raise Hand

Preconditioning Related to Love – Common misunderstandings

Excitement (from sensation, preconditioning) is confused for feeling

Sensation –
Lust, getting from the other
Continuity not possible

Preconditioning –
Infatuation
1. Love at First Sight?
2. By this age, I must have GF/BF?
3. The other has 4 GF/BF; I have only one?
Continuity not possible

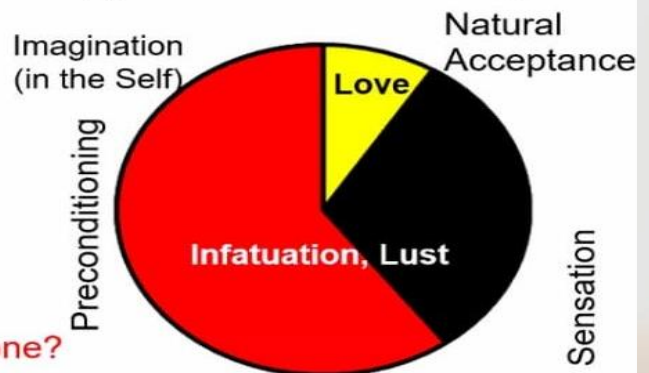

Right understanding (natural acceptance) –

Love (प्रेम) = **feeling** of being related to all, responsible towards all, giving to all
Continuity

Once trust, respect, affection, care, guidance... are ensured within, then the feeling of being related to all follows naturally

Members of Faculty, Dept. of ECE attended the fourth day of the five-day Online Workshop on "Incorporating Universal Human Value in Technical Education for VC's, Directors, Deans and UHV Conveners" organized by AICTE and hosted by Anna University on 14 May 2020.

MEETINGS & DISCUSSIONS

Zoom Meeting Interface: You are viewing MANOJ SMP's screen. View Options

Executive Bungalow – Front Elevation

WATER TANK, WINDOW, HAND RAILING, BAY WINDOW, ELEVATION

Participants: Ms. S. Dharsana Asst..., SREEVIDYA V, Arun Pandian.P.D, MANOJ SMP

Zoom Controls: Security, Participants (12), Chat, Share Screen, Pause/Stop Recording, Reactions, End (Alt+O)

Zoom Meeting Interface: You are viewing MANOJ SMP's screen. Speaker View, Exit Full Screen

Beam

Roof beam reinforcement from E-tabs

Barath kumar

Participants: Ms. S. Dharsana..., Dona, SREEVIDYA V, Mr. R. Ramesh Asst...

Zoom Controls: Unmute, Start Video, Security, Participants (13), Chat, Share Screen, Pause/Stop Recording, Reactions, End

Dr V Sreevidya, Asso. Professor, Dept. of Civil Engineering conducted the **In-Plant Training Review** for the II M.E. Structural Engineering Students via Zoom on 14 May 2020.

OUTREACH ACTIVITY



Helping the needy amidst COVID-19 lockdown: The Dept. of ICE in association with Green India NGO, donated things to the underprivileged people at Veerapandi Village, near Periyanyakkanpalayam, Coimbatore District on 13 May 2020.

God has given us two
hands, one to receive
with and the other
to give with.

Billy Graham

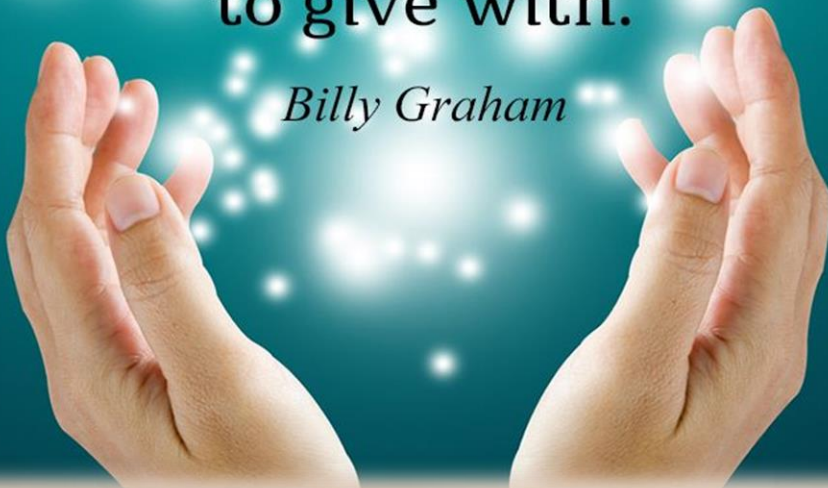

'Panic-gogy' (for panic + pedagogy): **Teaching Online Classes during the Coronavirus Pandemic**



Use of collocations in the wake of COVID-19

Collocation refers to words that are found together in language. Repeated exposure to the following collocations will subconsciously settle in our mind and enrich our word repository during this COVID-19 Pandemic. The following words are doing the rounds in the electronic and mass media today.

Social distancing - Janata Curfew - home quarantine - lockdown blues - hand hygiene - safety gear - thermal screening - physical distance - social isolation - sealing borders - self-quarantine - cough and sneeze etiquette - sneeze into your elbow - stay home India - and many more.