



SKCT

DIGEST

SPECIAL ISSUE 9

20 - 24 JULY 2020

EDITOR - IN - CHIEF

**Dr Srinivasan Alavandar,
Principal**

EDITORIAL TEAM

Ms S Soundarya, CSE

Ms S Thenmozhi, ECE

Mr N SethuNarayanan, SSH



INSIDE THIS ISSUE

SKCT | RECOGNITION

Pg.no. 3 - 4

FACULTY GUEST SPEAKER

Pg.no. 5 - 6

PROPOSALS SANCTIONED

Pg.no. 7 - 9

CIA THROUGH ONLINE MODE

Pg.no. 10 - 13

STUDENTS' PARTICIPATION

Pg.no. 14 - 23

FACULTY PARTICIPATIONS

Pg.no. 24 - 29

NEW VISTAS OF LEARNING

Pg.no. 30 - 47

WORKSHOPS ATTENDED

Pg.no. 48 - 50

FDPs ATTENDED

Pg.no. 51 - 63

MEETINGS & DISCUSSIONS

Pg.no. 64 - 66

EVENTS ORGANIZED

Pg.no. 67 - 68



SKCT RECOGNITION



SPECIAL EDITION 9



[@skctdigest](https://twitter.com/skctdigest)



[@skctofficial](https://www.facebook.com/skctofficial)



digestfeedback@skct.edu.in

SKCT | EC-COUNCIL ACADEMIA PARTNER – CYBER SECURITY

EC-COUNCIL | ACADEMIA
PARTNER

EC-Council recognizes this institution as an authorized EC-Council Academia Partner. The EC-Council Academia Partner network is the premier partnership for delivering high-quality, authorized EC-Council Cybersecurity related academic courses.

Sri Krishna College of Technology

Accredited Institution

July 22, 2020

July 22, 2023

EACD44552

Date of Issue

Expiry Date

Region

Partner ID



Wesley Adams

Director of Academics



Sri Krishna College of Technology has been recognized as an authorized “**EC-Council Academia Partner**” from 22 July 2020. The EC-Council Academia Partner network is the premier partnership for delivering high-quality, authorized EC-Council Cyber Security related academic courses.





FACULTY GUEST SPEAKER



SPECIAL EDITION 9



@skctdigest



@skctofficial



digestfeedback@skct.edu.in

SoM | GUEST SPEAKER

INTERNATIONAL MULTIDISCIPLINARY E-CONFERENCE ON SUSTAINABLE PRACTICES IN GLOBAL BUSINESS & SAFETY FOR EXCELLENCE
(An Industry Institute Interaction Initiative)

TECHNICAL SESSION ON
EMERGING TRENDS IN GLOBAL BUSINESS
STRATEGIES FOR SUSTAINABILITY

19th July, 2020

SESSION CHAIR



Mr.KEERTHI MARIAPPAN
Associate General Manager
TATA Consultancy Services

SPEAKERS



Ms.G.NAGARANI
MANAGER-LEGAL (HEAD) PROCONNECT SUPPLY
CHAIN SOLUTIONS (A REDINGTON GROUP OF COMPANIES), Chennai



Prof.LAKSHMI NARASIMHAN
Professor, Alliance Business School
Alliance University, Bangalore



Dr.PADMAVATHY
Professor & Head, Department of Business Studies
Sri Krishna College of Technology



Dr.P.SORUBARANI
Head, Department of Commerce (PG & Research)
Mary Matha College of Arts & Science, Periyakulam



Dr.S.RENGARAJ
Head, Department of commerce (sf)
Mannar Thirumalai Naicker College, Madurai

Jointly Organised by

For Registration:
9842154884



meet.google.com/xcp-zduk-svk
Date:19/7/2020
Time: (10.00 am to 12.00 noon)



Dr M Padmavathi, Professor and Head, School of Management, delivered a Technical Talk on “**Emerging Trends in Global Business Strategies for Sustainability**” in the International Multidisciplinary E-Conference on Sustainable Practices in Global Business & Safety for Excellence on 19 July 2020.



PROPOSALS SANCTIONED



SPECIAL EDITION 9



@skctdigest



@skctofficial



digestfeedback@skct.edu.in

SoM | AQIS-STTP



All India Council for Technical Education (Under Ministry of HRD, GOI) AICTE Quality Improvement Schemes – AQIS

STTP – Short Term Training Program

Dr J Chandrakhanthan and Mr A Prasath Kumar, Asst. Professors, School of Management, had received provisional recommendation from AICTE under AQIS scheme for organizing an Short Term Training Programme (STTP) on “Outcome Based Curriculum Planning, Mapping and Measurement”.

MECH | STTP GRANT APPROVAL

Short Term Training Programme (STTP)



Dr R Srinivasan, Professor, Dept. of Mechanical Engineering, had received provisional recommendation from AICTE under AQIS scheme for organizing an Short Term Training Programme (STTP) in “Enhancing Research and Development through Project Based Learning to achieve Outcome Based Education in Engineering” .



SKCT | CIA THROUGH LIVE ONLINE MODE

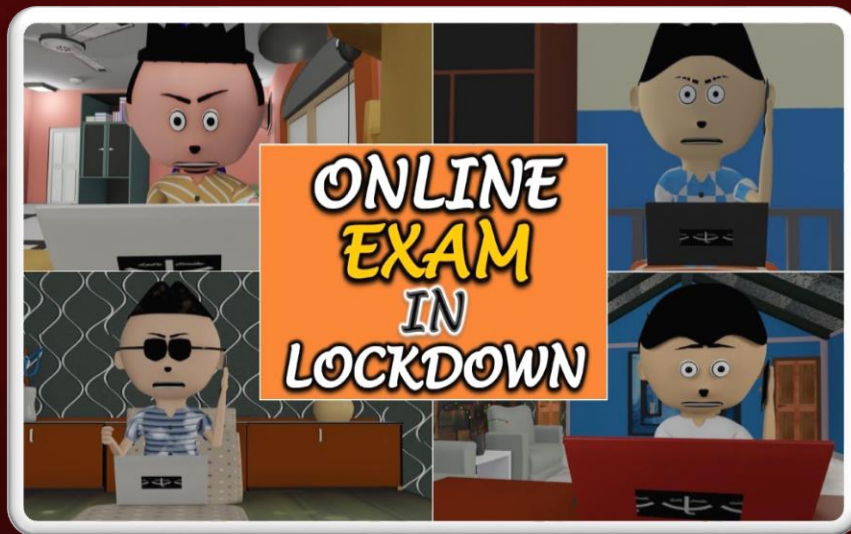

SPECIAL EDITION 9



@skctdigest



@skctofficial



digestfeedback@skct.edu.in

SKCT | CONTINUOUS INTERNAL ASSESSMENTS THROUGH LIVE ONLINE MODE

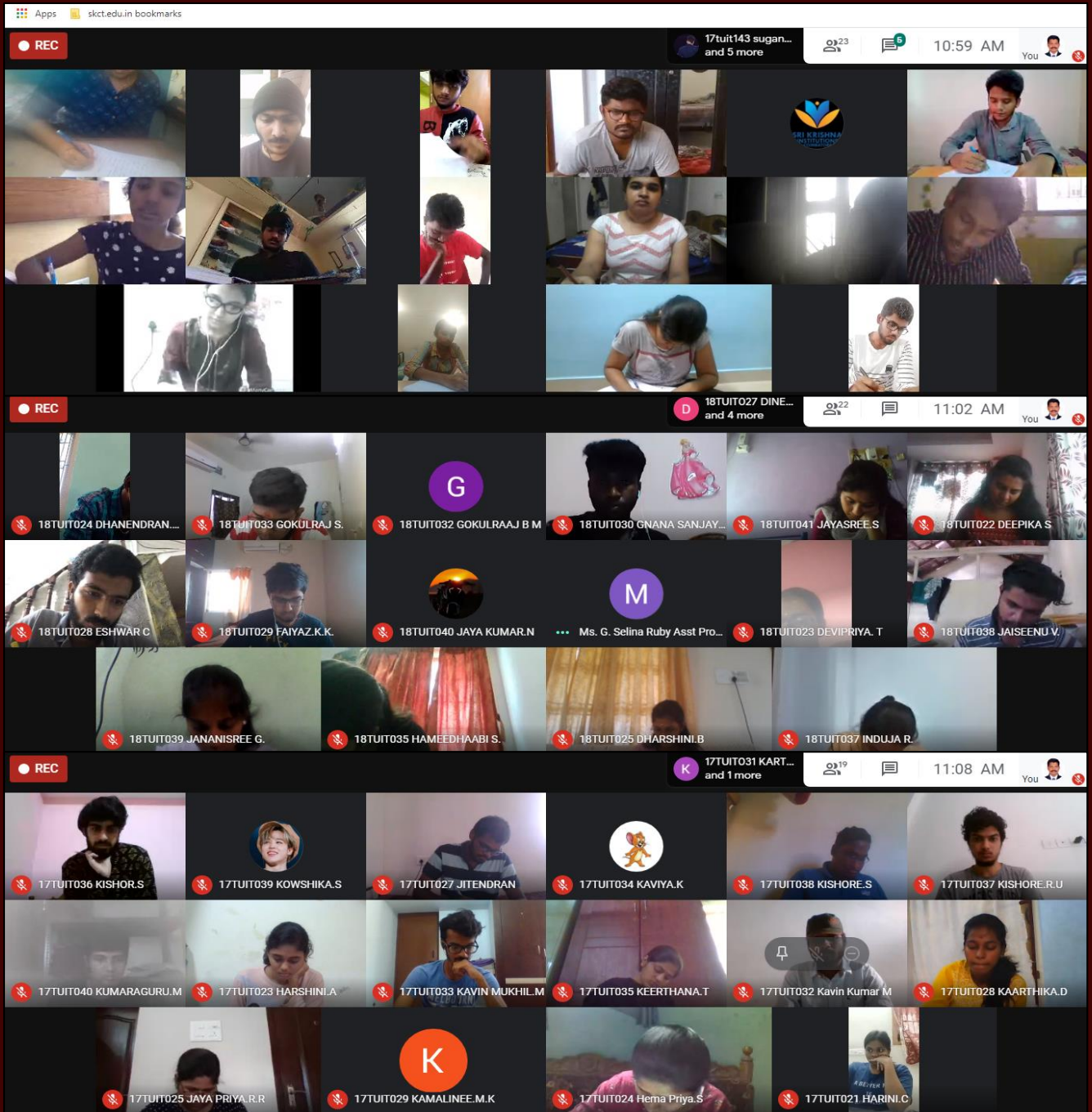

Students of Second, Third and Final Year B.Tech. IT actively participated in the Online Assessments conducted during 20-24 July 2020.

SKCT | CONTINUOUS INTERNAL ASSESSMENTS THROUGH ONLINE MODE

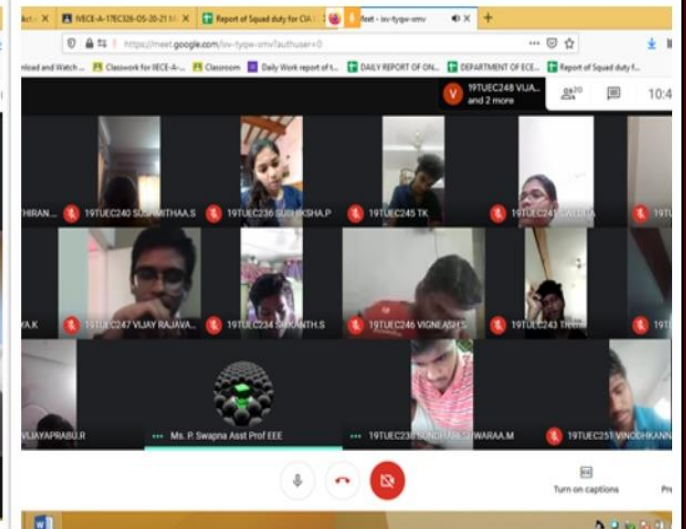
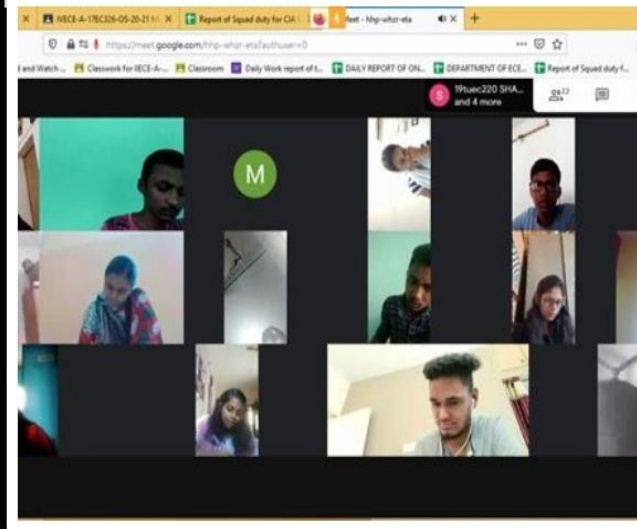
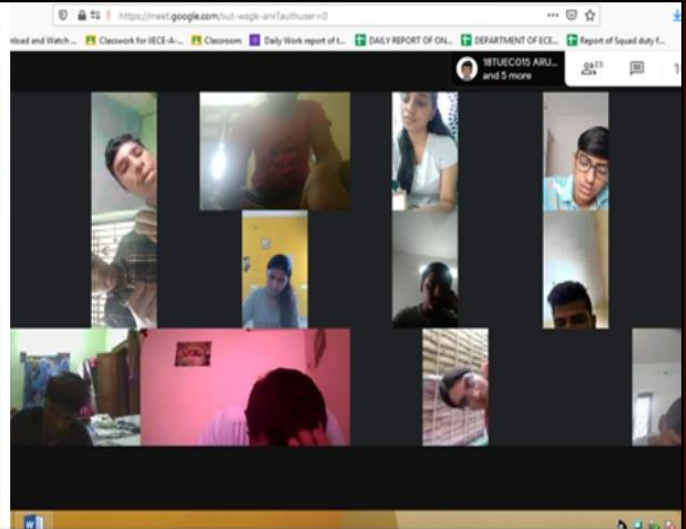
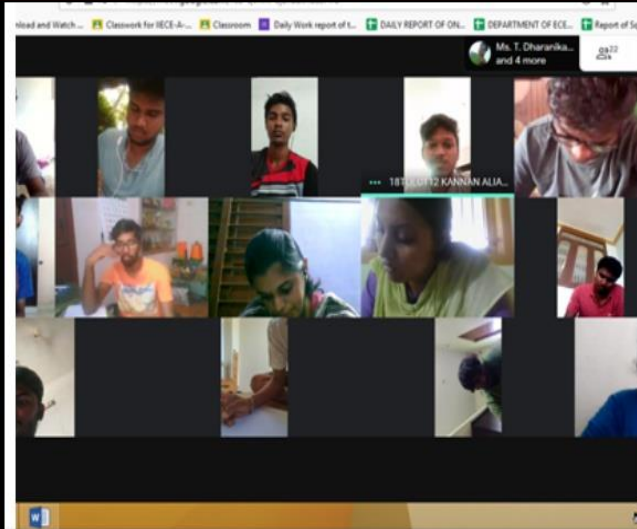

Students of Second, Third and Final B.E. ECE actively participated in the Online Assessments conducted on 20 - 24 July 2020.

SKCT | CONTINUOUS INTERNAL ASSESSMENTS THROUGH ONLINE MODE

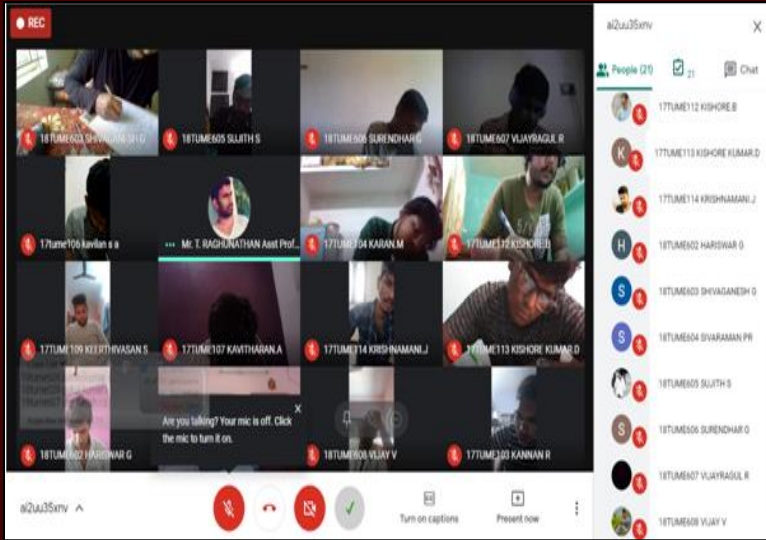

Dr P Prathap, Professor and Head, Dept. of Mechanical Engineering, monitored the Students of B.E. Mechanical Engineering during the CIA One Exams on 21 July 2020.

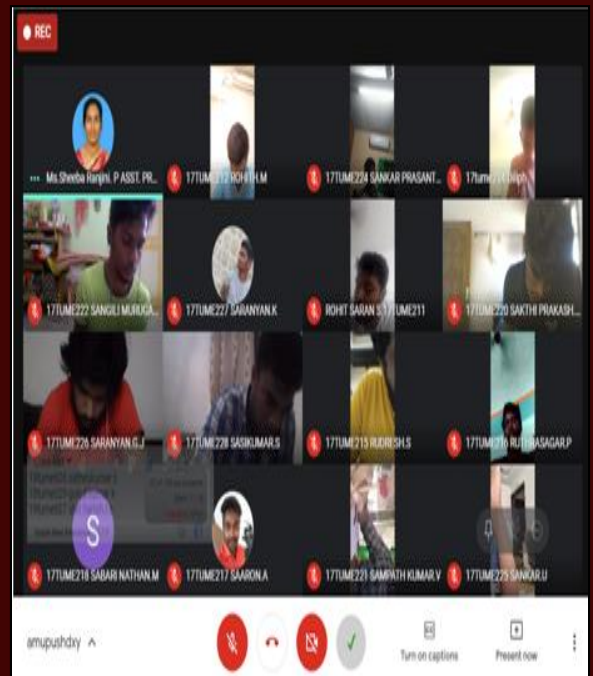



STUDENTS' PARTICIPATION



SPECIAL EDITION 9



@skctdigest



@skctofficial



digestfeedback@skct.edu.in

EEE | STUDENT'S YOUTUBE CHANNEL



Eternal Engineer's Solutions

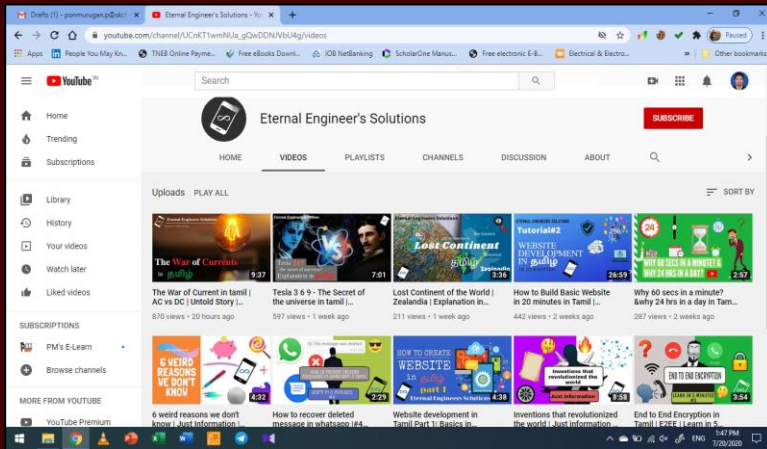

Students of Final Year B.E. Electrical and Electronics Engineering Mr N.S. Kokul, Mr N.S. Krishna, Mr G. Hariesh, Mr M. Kavinkumar, Mr S. Kishore aravindh, Mr B. Mohan and Mr M.K.Raj sivaram, started their YouTube Channel named “**ETERNAL ENGINEERS SOLUTIONS**” to discuss the fundamentals concepts in engineering and technology. The Channel aims to explain the complex scientific concepts in a simplified manner.

CSE | STUDENT'S ACHIEVEMENT | EXCLUSIVE MEMBER OF THE HARVARD BUSINESS REVIEW

HBR Ascend Select 3:42 PM
to me ▾

 HARVARD BUSINESS REVIEW

Hi Vishnu,

Congratulations! You are now a member of HBR Ascend Select. We're excited to welcome you to our community of aspiring leaders.

Here's your social badge for becoming a member of HBR Ascend Select.



You can click on the image to download your social badge.



Mr Vishnu Varthan, Student of Third Year B.E. CSE C Section, has been selected as an **Exclusive Member of the Harvard Business Review (HBR)**. HBR Ascend Select is an exclusive invite for aspiring leaders handpicked by HBR Ascend. As a member, he got the opportunity to share his views and opinions with the editorial, marketing and product teams of HBR Ascend.

CSE | STUDENT'S ACHIEVEMENT | KAGGLE RANKING

Vishnu Varthan Rao
Student at Sri Krishna College of Technology
Coimbatore, Tamil Nadu, India
Joined 3 months ago · last seen in the past day
Followers 11
Following 17
Datasets Expert

Home Datasets (3) Notebooks (7) Discussion (40) Followers (11) Contact User Follow User

Competitions Contributor	Datasets Expert	Notebooks Expert	Discussion Contributor
Unranked	Rank 116 of 22,045	Current Rank 641 of 132,536 Highest Rank 627	Unranked
0 0 0	0 0 3	0 0 5	0 3 21
No competition results	<ul style="list-style-type: none"> Windows Store 17 votes (14 days ago) Transit Bus Dat... 13 votes (16 days ago) Petrol Price in In... 9 votes (13 days ago) 	<ul style="list-style-type: none"> Inside Microsoft... 15 votes (13 days ago) Basics of Webs... 13 votes (14 days ago) Netflix EDA 10 votes (15 days ago) 	<ul style="list-style-type: none"> 100days to lear... 6 votes (17 days ago) Flask Tutorial Re... 5 votes (17 days ago) How to learn NL... 5 votes (3 months ago)

Mr Vishnu Varthan Student of Third Year B.E. CSE C Section, is ranked 117 in **Data Set Category** and 638 in **Kernels Category** in Kaggle - Data Science Platform, where working professionals students from all over the world showcase their skills.

Kaggle is the place to do data science projects



EEE | STUDENT'S PROJECT | FALLING WALLS LAB INDIA 2020

Dear Vasanth k,

Congratulations! You have been selected to contest in the Falling Walls Lab India 2020.

This year the Lab will take place online. It will consist of all the selected candidates pitching their ideas in 2.5 + 0.5 minutes flat, a jury from India and Germany evaluating them, 3 Falling Walls Lab winners and one DAAD Entrepreneurship Prize winner being selected, all in presence of a discerning audience.

Traditionally the prize for the first winner of the Falling Walls Lab included the chance to go to Berlin to contest in the Lab finale and the winner of the DAAD Entrepreneurship Prize went to Germany to participate in an entrepreneurship boot camp. This year, given the situation that the entire world is going through, the Germany action will not take place. However, we are working on alternate prizes by the DWIH New Delhi, which are likely to be in form of online training or mentoring by our partners in Germany engaged in research entrepreneurship.

We shall share more information with you, once we have your binding confirmation of participation. The Lab is likely to take place in the second half of August 2020.



Final Year B.E. EEE C Section Student Mr K Vasanth has been selected for the next round in the **Falling Walls Lab India 2020**, a grand event. The India Edition 2020 will be organized and hosted by DWIH New Delhi and DAAD in partnership with IIT Kanpur, and will take place at IIT Kanpur on 22nd August 2020. The winner will get a chance to go Berlin, Germany. The project was mentored by Mr P Leninpugalhanthi, Asst. Professor, Dept. of Electrical and Electronics Engineering.

CSE | STUDENT'S ACHIEVEMENT | INTERSHIP OFFER

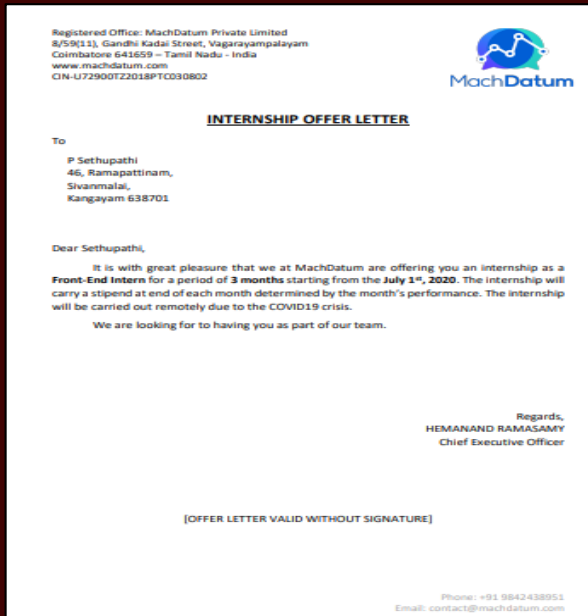

Mr P Sethupathi, Student of Third Year B.E. CSE C Section got an Internship Offer in MachDatum Pvt Ltd, Coimbatore as a **“Front-End Intern”** for a period of three months starting from 1 July 2020.

CSE | STUDENT CERTIFICATION | ONLINE COURSE
ON LEARNING MEAN STACK BY BUILDING REAL
WORLD APPLICATION

Mr T Matheas, Student of Third Year B.E. CSE B Section, completed 14.5 hours of Online Course of **“Learning Mean Stack by Building Real World Application”** offered by Udemy.

MECH | STUDENTS' PARTICIPATION | DRUG DISCOVERY HACKATHON 2020

Students from B.E. Mechanical Engineering attended the Drug Discovery Hackathon 2020 Training program on 17 July 2020.

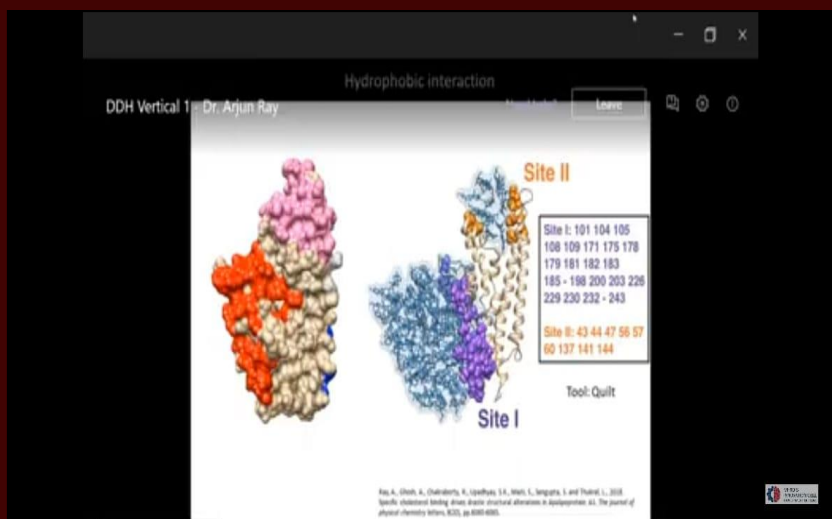

CSE | STUDENT'S PARTICIPATION | E-QUIZ ON CLOUD COMPUTING



Mr K Hari Krishnan, Student of Third Year B.E. CSE C Section, completed the quiz on “Cloud Computing” organized by Pune Vidyarthi Griha’s College of Engineering, Nashik on 17 July 2020.

IT | STUDENT PARTICIPATION | THE FUNDAMENTALS OF DIGITAL MARKETING

Mr P Balakrishnan, Student of Third Year B.Tech. IT A Section, successfully completed the Certification Course on “The Fundamentals of Digital Marketing” offered by The Open University in Google Digital Unlocked on 22 July 2020.



CSE | STUDENTS' PARTICIPATION | NEW INDIA LEARNATHON 2020



Learnathon™
learn lead inspire



Students of Third Year B.E CSE participated in the “NEW INDIA LEARNATHON 2020” organized by ICT Academy during May-June 2020.

MECH | STUDENT PARTICIPATION ON INDOOR AIR QUALITY – TECHNICAL TALK

Organizers:



NSAKCET Student Chapter



Mechanical Engineering Department
Nawab Shah Alam Khan
COLLEGE OF ENGINEERING & TECHNOLOGY
Malakpet, Hyderabad

Indian Society of Heating,
Refrigerating and Air Conditioning
Engineers



Deccan Chapter

Certificate of Participation

This is to certify that
Pradeepkumar S

Sri Krishna College of Technology, Coimbatore

has actively participated in **Technical Talk** on the topic
Indoor Air Quality - Creating Healthier Spaces
presented by **Mr. Anand Babu Rao**,
(President, ISHRAE Deccan Chapter)
as a part of **Webinar Series** on
“Emerging Trends & Opportunities in HVAC”
on **18-July-2020**.

Swetha Jain
Student Chair,
ISHRAE Deccan Chapter

Raza A Khan
Faculty Advisor, ISHRAE
Students Chapter @NSAKCET

Dr. S Mujahed Hussaini
Head, Department of
Mechanical Engg, NSAKCET

Certificate ID: NSAKCET-MED-20200720

* This certificate is digitally signed



Mr S Pradeepkumar, Student of Third Year B.E. Mechanical Engineering, participated in the Technical Talk on **“Indoor Air Quality - Creating Healthier Spaces”** facilitated by Mr Anand Babu Rao, President, ISHRAE, Deccan Chapter on 18 July 2020.



FACULTY PARTICIPATIONS



SPECIAL EDITION 9



@skctdigest



@skctofficial



digestfeedback@skct.edu.in

PRINCIPAL SKCT | ICT ACADEMY CONVERGENCE 2020



Dr Srinivasan Alavandar, Principal, SKCT attended the “ICT Academy Convergence 2020” (Annual Members Meeting) organized by ICT Academy on 15 July 2020.

CSE | ONLINE CERTIFICATION ON CLOUD COMPUTING BASICS (CLOUD 101)



Ms G Sandhya, Asst. Professor, Dept. of CSE, completed an online non-credit course “Cloud Computing Basics (Cloud 101)” authorized by LearnQuest offered by Coursera on 23 July 2020.

**IT | CERTIFICATION
ON PYTHON DATA
STRUCTURES**



Dr A Christy Jeba Malar,, Assoc. Professor, Dept. of IT completed “Python Data Structures”, an online course authorized by University of Michigan and offered through Coursera on 19 July 2020.

Dr D Jeyabharathi, Asst. Professor, Dept. of IT completed “Data Collection and Processing with Python”, an online course authorized by University of Michigan and offered through Coursera on 18 July 2020.

**IT | CERTIFICATION
ON DATA COLLECTION
AND PROCESSING
WITH PYTHON**

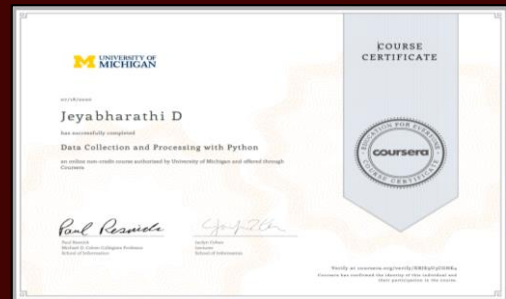

Dr D Jeyabharathi, Asst. Professor, Dept. of IT completed the Online Technical Quiz on “Python Programming” organized by VAAGDEVI Engineering College in association with VEC-CSI on 16 July 2020.

**IT | QUIZ ON
PYTHON
PROGRAMMING**

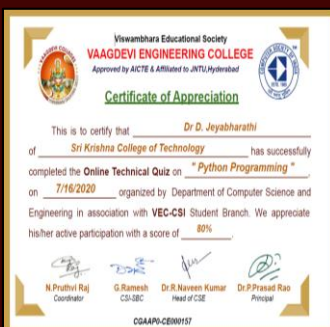

CSE | FACULTY CERTIFICATION ON PROGRAMMING FOR EVERYBODY (GETTING STARTED WITH PYTHON)

Ms G Sandhya, Asst. Professor, Dept. of CSE, completed an online non-credit course on **“Programming for Everybody (Getting Started with Python)”** authorized by University of Michigan and offered through Coursera.



CSE | FACULTY CERTIFICATION ON PROGRAMMING FOR EVERYBODY



Dr. M. Deva Priya, Asso. Professor, Dept. of CSE completed an online non-credit course on **“Cloud Computing Basics (Cloud 101)”** authorized by LearnQuest and offered through Coursera.

CSE | NATIONAL LEVEL TECH QUIZ ON DATA STRUCTURES, OPERATING SYSTEM AND C++

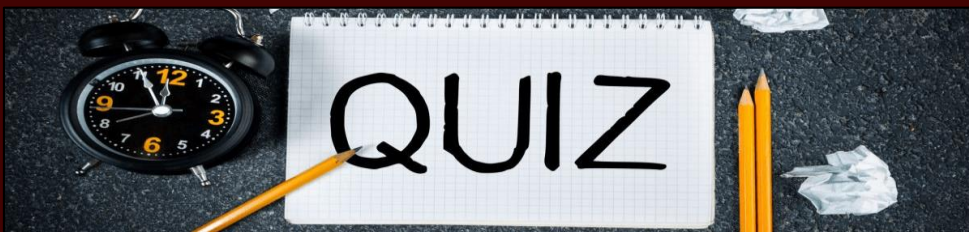

Dr. M. Deva Priya, Assoc. Professor, Dept. of CSE, attended a National level TECH Quiz on 'Data Structures, Operating system and C++' organized by School of CSE & IT, JAIN (Deemed-to-be-University), Bengaluru, Karnataka on 18. July 2020.

MECH | QUIZ ON INTELLECTUAL PROPERTY INDIA

Sri Krishna College of Technology
An Autonomous Institution | Approved by AICTE
Affiliated by Anna University | Accredited by NAAC with 'A' Grade
Kovalapur, Coimbatore 641042
www.skct.edu.in

ISHRAE
COIMBATORE CHAPTER

INSTITUTION'S INNOVATION COUNCIL
University of Anna University

This E-Certificate is proudly presented to
Dr.Prince Muthiah
Sri Krishna College of Technology

who has successfully completed Online Quiz on "Intellectual Property Rights" organised by Sri Krishna College of Technology on 16th July, 2020.

Dr. P. Prathap
HoD, Mechanical Engineering

Dr. G.M.Tamilselvan
HoD, Information Technology

Dr.Srinivasan Alavandar
Principal

Please note that this E-Certificate is generated by the software application and hence requires no authorized signature

Sri Krishna College of Technology
An Autonomous Institution | Approved by AICTE
Affiliated by Anna University | Accredited by NAAC with 'A' Grade
Kovalapur, Coimbatore 641042
www.skct.edu.in

ISHRAE
COIMBATORE CHAPTER

INSTITUTION'S INNOVATION COUNCIL
University of Anna University

This E-Certificate is proudly presented to
Mr. S. Ram Kumar
Sri Krishna College of Technology, Coimbatore

who has successfully completed Online Quiz on "Intellectual Property Rights" organised by Sri Krishna College of Technology on 16th July, 2020.

Dr. P. Prathap
HoD, Mechanical Engineering

Dr.G.M.Tamilselvan
HoD, Information Technology

Dr.Srinivasan Alavandar
Principal

Please note that this E-Certificate is generated by the software application and hence requires no authorized signature

Sri Krishna College of Technology
An Autonomous Institution | Approved by AICTE
Affiliated by Anna University | Accredited by NAAC with 'A' Grade
Kovalapur, Coimbatore 641042
www.skct.edu.in

ISHRAE
COIMBATORE CHAPTER

INSTITUTION'S INNOVATION COUNCIL
University of Anna University

This E-Certificate is proudly presented to
Mr.R.Harikrishnan
Sri Krishna College of Technology

who has successfully completed Online Quiz on "Intellectual Property Rights" organised by Sri Krishna College of Technology on 16th July, 2020.

Dr. P. Prathap
HoD, Mechanical Engineering

Dr.G.M.Tamilselvan
HoD, Information Technology

Dr.Srinivasan Alavandar
Principal

Please note that this E-Certificate is generated by the software application and hence requires no authorized signature

Sri Krishna College of Technology
An Autonomous Institution | Approved by AICTE
Affiliated by Anna University | Accredited by NAAC with 'A' Grade
Kovalapur, Coimbatore 641042
www.skct.edu.in

ISHRAE
COIMBATORE CHAPTER

INSTITUTION'S INNOVATION COUNCIL
University of Anna University

This E-Certificate is proudly presented to
Mr.R.Rathish
Sri Krishna College of Technology

who has successfully completed Online Quiz on "Intellectual Property Rights" organised by Sri Krishna College of Technology on 16th July, 2020.

Dr. P. Prathap
HoD, Mechanical Engineering

Dr.G.M.Tamilselvan
HoD, Information Technology

Dr.Srinivasan Alavandar
Principal

Please note that this E-Certificate is generated by the software application and hence requires no authorized signature

Sri Krishna College of Technology
An Autonomous Institution | Approved by AICTE
Affiliated by Anna University | Accredited by NAAC with 'A' Grade
Kovalapur, Coimbatore 641042
www.skct.edu.in

ISHRAE
COIMBATORE CHAPTER

INSTITUTION'S INNOVATION COUNCIL
University of Anna University

This E-Certificate is proudly presented to
Rajeswaran M
Sri Krishna college of Technology

who has successfully completed Online Quiz on "Intellectual Property Rights" organised by Sri Krishna College of Technology on 16th July, 2020.

Dr. P. Prathap
HoD, Mechanical Engineering

Dr. G.M.Tamilselvan
HoD, Information Technology

Dr.Srinivasan Alavandar
Principal

Please note that this E-Certificate is generated by the software application and hence requires no authorized signature



Members of Faculty and Students in the Dept. of Mechanical Engineering participated in the **Intellectual Property Rights quiz** organized by Sri Krishna College of Technology on 16 July 2020



NEW VISTAS OF LEARNING



SPECIAL EDITION 9



@skctdigest



@skctofficial



digestfeedback@skct.edu.in

ECE | WEBINAR ON FUNCTIONAL VERIFICATION OF COMPLEX SOC DESIGN USING UVM

Ms S Kiruthiga, Asst. Professor, Dept. of ECE attended a Webinar on **“Functional Verification of Complex SoC design using UVM”** organized by PSG Institute of Technology and Applied Research, Coimbatore on 20 July 2020.



ECE | WEBINAR ON RESEARCH AREAS AND OPPORTUNITIES IN ENVIRONMENTAL SCIENCE AND ENGINEERING

Dr S Malathy, and Dr K Sumathi, Professor,s, Mr R R Thirrunavukkarasu, Ms S Thenmozhi, Asst. professors, Dept. of ECE, attended a Webinar on **“Research Areas and Opportunities in Environmental Science and Engineering”** organized by Chennai Institute of Technology, Chennai on 18 July 2020.



IT | WEBINAR ON 2020 WOMAN IN POWER

Ms S Madumidha, Asst. Professor, Dept. of IT, participated in the International Webinar Series – WOMANSERA'20 on “2020 Woman in Power” organized under IEEE Woman in Engineering Affinity group of St. Joseph’s College of Engineering, Chennai on 16 July 2020.



IT | WEBINAR ON EDGE-FOG-CLOUD COMPUTING FOR BIG DATA ANALYTICS

Dr D Jeyabharathi, Asst. Professor, Dept. of IT, participated in National-Level One Day Webinar on “Edge-Fog-Cloud Computing for Big Data Analytics” organized by Dr. Sivanthi Aditanar College of Engineering, Tiruchendur on 17 July 2020.



ICE | WEBINAR ON MIGRATING SELF-MANAGED MYSQL DATABASES TO AMAZON RDS FOR MYSQL

Value of a fully managed service

Press **Esc** to exit full screen

Spend time innovating & building new apps, not managing infrastructure:

You

- Schema design
- Query construction
- Query optimization

AWS

- Automatic fail-over
- Backup & recovery
- Isolation & security
- Industry compliance
- Push-button scaling
- Automated patching & upgrades
- Advanced monitoring
- Routine maintenance

aws

Planning and requirements

Before migration, discover your requirements and existing capabilities

- What MySQL version are you using?
- What is the size of your database?
- Will you migrate the full data set, or parts of it?
- Do you have minimum downtime requirements?
- Do you use replicas today (binary logs)?
- How do you backup your data today?
- Do you have specific encryption and data protection requirements?

aws

Dr T Chinnadurai, Assoc. Professor, Dept. of ICE attended a webinar on “MIGRATING SELF-MANAGED MYSQL DATABASES TO AMAZON RDS FOR MYSQL” facilitated by Vijay Karumajji, AWS Solutions Architect on 20 June 2020.

ECE | WEBINAR ON INTERNET OF THINGS(IOT) AND ITS APPLICATIONS



Dr S Malathy, Professor, Dept. of ECE, attended a Webinar on “Internet of Things(IoT) and Its Applications” organized by Rajalakshmi Engineering College, Chennai on 19 July 2020.

ECE | WEBINAR ON HDL PROGRAMMING – UNLOCK YOUR PROGRAMMING SKILLS

Ms N Vijayalakshmi, Asst. Professor, Dept. of ECE, attended a Webinar on “HDL Programming – unlock Your Programming Skills” organized by Builders Engineering College, Tirupur on 20 July 2020.



SoM | WEBINAR ON THE OPPORTUNITY AHEAD



The Members of Faculty in the School of Management attended a webinar on “**The Opportunity Ahead**” facilitated by Dr Gururaj Deshpande, President & Chairman- Sparta Group LLC and Founder- Deshpande Foundation on 20 July 2020, organised by TiE Rajasthan.

ECE | WEBINAR ON ONLINE TEACHING TECHNIQUES AND TOOLS

Dr K Sumathi, Professor, Dept. of ECE, attended a Webinar on **“Online Teaching Techniques and Tools”** organized by Paavai Engineering College, Namakkal on 18 July 2020.



ECE | WEBINAR ON CHALLENGES FACED BY WOMEN LEADERS: LESSONS LEARNED AND FUTURE STRATEGIES



Dr K Sumathi, Professor, Dept. of ECE, attended a Webinar on **“Challenges Faced by Women Leaders: Lessons Learned and Future Strategies”** organized by Manonmaniam Sundaranar University on 21 July 2020.

ICE | WEBINAR ON CONTINUOUS WATER QUALITY MONITOR DEPLOYMENT TECHNIQUES

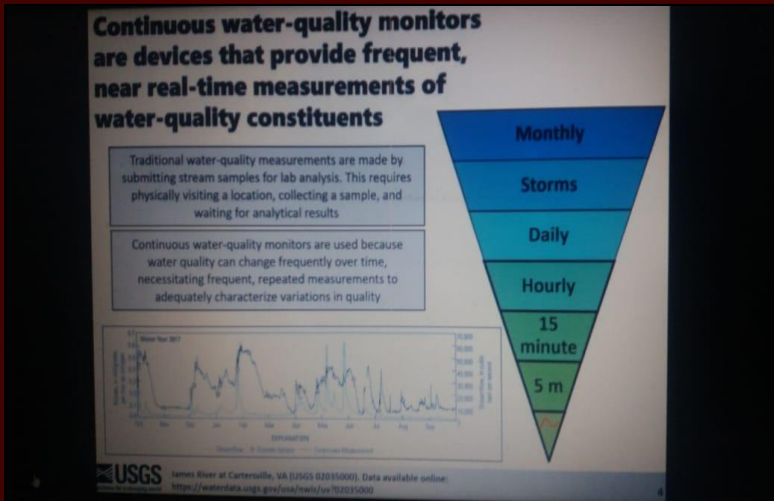
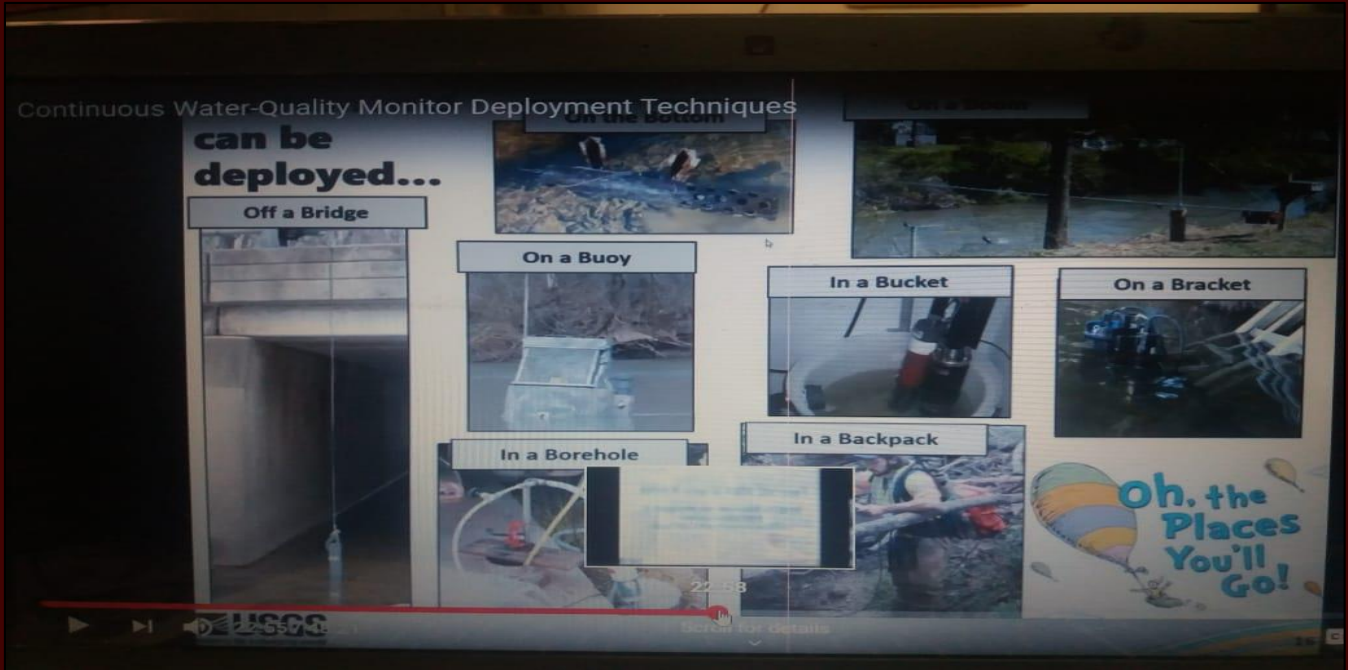

Ms K Shanthi, Asst. Professor, Dept. of ICE, attended a Webinar on “Continuous Water Quality Monitor Deployment Techniques” by John Joiner, Scientist, National Water Quality Monitoring Council on 21 July 2020.

MECH | WEBINARS ATTENDED | DIGITAL TRANSFORMATION & FUTURE OF JOBS



Mr K S Raghul, Asst. Professor, Dept of Mechanical Engineering, participated in the webinar on “**Digital Transformation & Future of Jobs**” organized by Axis Global Institute of Industrial Training on 11 July 2020.



Dr P Ponnmurugan, Assoc. Professor, Dept. of EEE, participated in the One-Day International Webinar on “**Navigation Satellites for Modern Telecommunications**” organized by the Dept. of Electronics & Communication Engineering, Malla Reddy Institute of Technology and Science, Hyderabad on 11 July 2020.

EEE | WEBINAR ON NAVIGATION SATELLITES FOR MODERN TELECOMMUNICATIONS



ICE | WEBINAR ON CREATING CLASSROOM EXPERIENCES USING THE AMAZON CHIME SDK

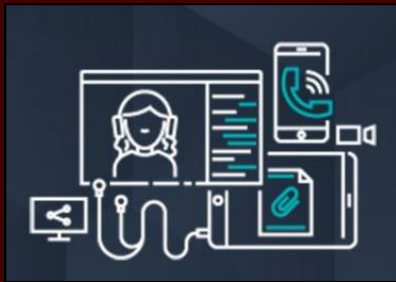
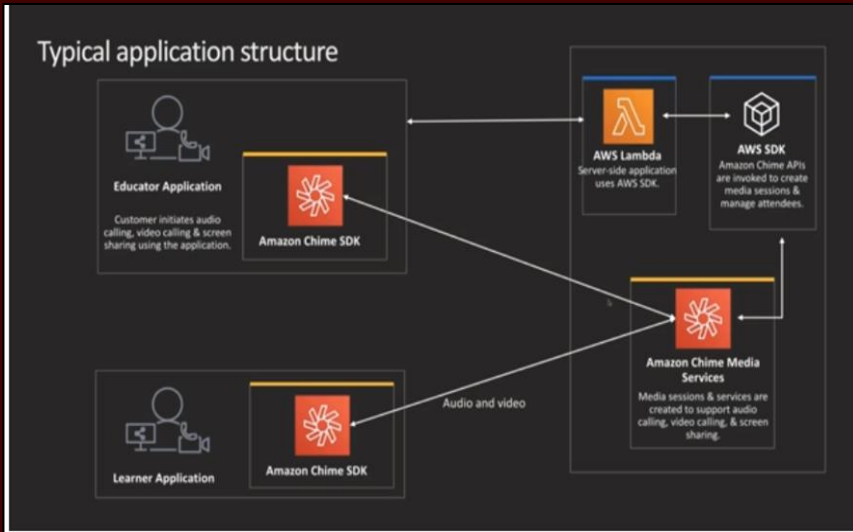

Amazon Chime SDK brings video to your apps Press Esc to exit full screen

- Build faster**
Ready to integrate SDKs
Abstract away WebRTC complexity
- Simplify Operations**
Enterprise-ready in 14 AWS regions
Pre-configured
No deployments required
- Extend Your Apps**
PSTN calling management
Add AI/ML capabilities

Reduce time-to-market, costs and overhead.

Dr M Karthigai Pandian & Dr T Chinnadurai, Assoc. Professors, and Mr J Dhanaselvam & Mr K Saravanakumar, Asst. Professors, Dept. of ICE, attended a Webinar on “**CREATING CLASSROOM EXPERIENCES USING THE AMAZON CHIME SDK**” facilitated by Sid Rao, General Manager - Chime, AWS on 21 June 2020.

CSE | WEBINAR ON DESIGN THINKING 101

Students and Members of Faculty in the Dept. of CSE attended a Webinar on **Go Crazy with Flutter** by Ms. Nikita Gandhi, Community Manager, Google organized by Learn with Community, GDG Cloud Coimbatore Team and an initiative by Mr R Manoj Aiyer, Student of Final Year B.E. CSE B section, SKCT on 19 July 2020.

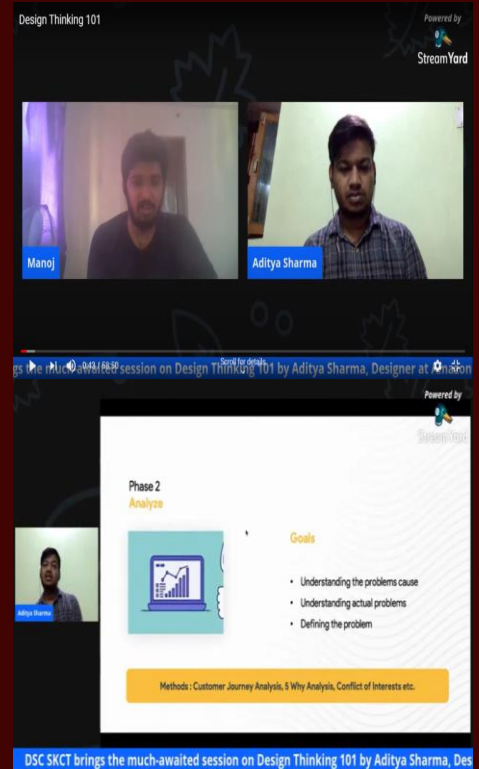

Mr S Dilip Kumar, Asst. Professor, Dept. of ICE, attended a Webinar on **“Reliable Cybersecurity between IT and OT Networks”** organized by ISA South India section, Chennai on 18 July 2020.

ICE | WEBINAR ON
RELIABLE
CYBERSECURITY
BETWEEN IT AND
OT NETWORKS



ECE | WEBINAR ON SIW TECHNOLOGY TOWARDS 5G APPLICATIONS: MINIATURIZATION, DESIGN AND MATERIALS



Mr G Santhakumar and Ms E L Dhivya Priya, Asst. Professors, Dept. of ECE attended a webinar on “SIW Technology towards 5G applications: Miniaturization, Design and Materials” organized by IEEE MTTs SB – chapter on 14 July 2020.

MECH | WEBINAR ON VALUE METHODOLOGY IN AUTOMOBILE INDUSTRY

Mr K S Raghul, Asst. Professor, Dept of Mechanical Engineering, participated in the webinar on “Value Methodology in Automotive Industry” facilitated by Mr P Arjunraj. The event was organized by Dept of Automobile Engineering, Bannari Amman Institute of Technology on 11 July 2020



IT | WEBINAR ON UNDERSTANDING ARTIFICIAL INTELLIGENCE TOOLS, PLATFORMS AND SERVICES

Ethiraj College For Women
Ethiraj Salai, Egmore, Chennai, Tamil Nadu 600008



CERTIFICATE
OF PARTICIPATION

THIS IS TO CERTIFY THAT

Ms.ROOPA V

SRI KRISHNA COLLEGE OF TECHNOLOGY

HAS ACTIVELY PARTICIPATED IN THE WEBINAR ON

" UNDERSTANDING ARTIFICIAL INTELLIGENCE TOOLS , PLATFORMS & SERVICES "

ORGANIZED BY DEPARTMENT OF B.Sc.COMPUTER SCIENCE,

ETHIRAJ COLLEGE FOR WOMEN, CHENNAI

IN ASSOCIATION WITH PANTECH E LEARNING ON 08th JULY 2020.

SRINIVASAN N, DIRECTOR
PANTECH E LEARNING

Ms.K JANE NITHYA,
HEAD OF THE DEPARTMENT

J MEENAKSHI
ORGANIZING SECRETARY

DR.S.KOTNAI
PRINCIPAL & SECRETARY

PELETHIAI_08_07_1015

www.pantechlearning.com

Pantech e Learning
ONLINE LEARNING PLATFORM

Ms V Roopa, Asst. Professor, Dept. of IT, participated in the Webinar on "Understanding Artificial Intelligence Tools, Platforms and Services" organized by Ethiraj College for Women in association with PANTECH E Learning on 08 July 2020.

EEE | WEBINAR ON EVERYONE CAN DO QUALITY RESEARCH



Dr K Gaayathry, Asst. Professor, Department of EEE, participated in the webinar series on **“Everyone can do quality research – Innovative Research”** organized by the Internal Quality Assurance Cell (IQAC), Knowledge Institute of Technology, Salem on 23 July 2020.

EEE | WEBINAR ON INTRODUCTION TO TECHNOLOGY RESOURCES, FUNDING OPPORTUNITIES AND ENTREPRENEURSHIP PROGRAMS



SRM INSTITUTE OF SCIENCE AND TECHNOLOGY
FACULTY OF ENGINEERING AND TECHNOLOGY
RAMAPURAM CAMPUS
CHENNAI, TAMIL NADU - 600089



PARTICIPATION CERTIFICATE

This is to certify that **S Saravanan** from **Sri Krishna College of Technology** has participated in the *Webinar on An Introduction to Technology Resources, Funding*



SRM INSTITUTE OF SCIENCE AND TECHNOLOGY
FACULTY OF ENGINEERING AND TECHNOLOGY
RAMAPURAM CAMPUS
CHENNAI, TAMIL NADU - 600089



PARTICIPATION CERTIFICATE

This is to certify that **Leninpugalhanthi** from **Sri Krishna College of Technology** has participated in the *Webinar on An Introduction to Technology Resources, Funding Opportunities and Entrepreneurship Programs at C-Camp* held on 22nd July 2020 conducted by Department of Mechanical Engineering, SRM Institute of Science and Technology, Ramapuram Campus, Chennai - 600089.

Dr. K.C. Udayakumar
Head of the Department

Dr.G.Selva kumar
Dean/E&T



ist.srmrmp.edu.in



[srmist.rmp](https://www.facebook.com/srmist.rmp)



[srmist.rmp](https://www.instagram.com/srmist.rmp)



18001021525

*electronically generated doesn't require signature

Dr S Saravanan and Mr P Leninpugalhanthi, Asst. Professors, Dept. of EEE, participated in the webinar on “An Introduction to Technology Resources, Funding Opportunities and Entrepreneurship programs” organized by the Dept. of Mechanical Engineering, SRM Institute of Science and Technology, Ramapuram Campus, Chennai on 22 July 2020.

SoM | WEBINAR ON FUTURE OF GLOBAL EDUCATION

TiE EDU-SIG - Journey so far...

- **Topic:** TiE Education SIG - Inside Workforce Development
Date: June 16, 2020 Speaker: **Karl Mehta Founder, EdCast Inc.**
In Conversation with Murali Bukkapatnam Chairman, Volkys Technologies.
- **Topic:** TiE Education SIG - Venture Investments in the Education Space
Date: July 9, 2020 Speaker: **Gopal Jain Managing Partner, GAJA Capital.**
In Conversation with Tariq Khan Trustee, TiE Global Board. Edu-SIG Chair
- **Topic:** TiE Education SIG - A fireside chat on 'Future of Global Education'
Date: July 23, 2020 Speaker: **Dr. Bala V. Balachandran, J. L. Kellogg Distinguished Professor, Northwestern University, USA and Founder, Chairman, Great Lakes Institute of Management.**
In Conversation with Kali Prasad Trustee, TiE Global Board.

About TiE EDU-SIG

- The purpose of this Special Interest Group is to bring the TiE entrepreneurs with special interest in **education** onto a common platform for **networking**, identifying **opportunities** and **learning** from eminent individuals in the sector.
- Empowering **Charter Members** to have impromptu discussions in smaller groups to work on the identified opportunities to build solutions that will impact society, generate employment and create wealth.
- This is a **forum** where any participating Member organizes events that can add value to the **Edu** and **Ed-Tech** entrepreneurs spread the sectoral business models and opportunities across the **Globe**.

Supported by
TiE HYDERABAD

tie.org | hyderabad.tie.org



The Members of Faculty in the School of Management attended a Webinar on “Future of Global Education” on 23 July 2020, organised by TiE Hyderabad.

ECE | WEBINAR ON DEVICE DESIGN FOR COMBATING EMERGING LEAKAGE MECHANISM IN THE NOVEL NANOSCALE FET ARCHITECTURES

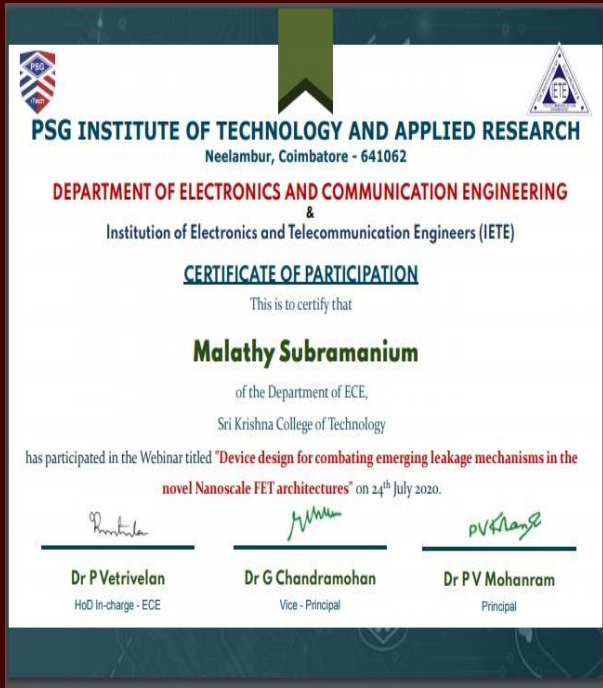

Dr S Malathy, Professor, Dept. of ECE has been certified for attended webinar on "Device design for combating emerging leakage mechanism in the novel Nanoscale FET architectures" organized by PSG Institute of Technology and Applied research on 24 July 2020.

ECE | WEBINAR ON EXCELLENCE THROUGH TQM



Dr S Malathy, Dr K Sumathi, Professors and Mr R R Thirunavukkarasu, Asst. Professor, Dept. of ECE attended a webinar on "Excellence Through TQM" organized by Chennai Institute of Technology, Chennai on 23 July 2020.

ECE | WEBINAR ON ENGINEERING A PASSIONATE JOURNEY TOWARDS SUCCESS



Dr K Sumathi, Professor, Dept. of ECE, attended a Webinar on “Engineering a Passionate Journey Towards Success” organized by Mohamed Sathak AJ College of Engineering, Chennai on 22 July 2020.

ECE | FEMINAR SERIES

Dr K Sumathi, Professor, Dept. of ECE, attended a **three-day Feminar Series** organized by St. Joseph’s Institute of Technology during 11 - 13 July 2020.





WORKSHOPS ATTENDED



SPECIAL EDITION 9



@skctdigest



@skctofficial



digestfeedback@skct.edu.in

CSE | E-WORKSHOP ON CYBER SECURITY



Ms A Sunitha Nandhini, Ms S Padmavathi and Ms G Nivedhitha, Asst. Professors, Dept. of CSE, attended a three-day E-Workshop on “Cyber Security” during 18-20 July 2020 organized by PSG Institute of Technology and Applied Research in association with CSI.

IT | WORKSHOP ON CYBER SECURITY



Dr R Suganya, Asst. Professor, Dept. of IT, attended a three-day International E-Workshop on “Cyber Security” organized by PSG Institute of Technology and Applied Research in association with Computer Society of India(CSI) during 18 - 20 July 2020.

ECE | E-WORKSHOP ON CYBER SECURITY



Dr Sumathi, Professor, Dr Senoj Joseph, Assoc. professor and Ms S Thenmozhi, Assistant Professor, Dept. of ECE, attended a three-day International E-Workshop on “Cyber Security” organized by PSG Institute of Technology and Applied Research, Coimbatore during 18 - 20 July 2020.





FDPs ATTENDED



SPECIAL EDITION 9



@skctdigest



@skctofficial



digestfeedback@skct.edu.in

IT | FDP ON ARTIFICIAL INTELLIGENCE APPLICATIONS THROUGH MACHINE LEARNING



Dr D Jeyabharathi, Asst. Professor, Dept. of IT, participated in the National-Level Online Faculty Development Program on “Artificial Intelligence Applications through Machine Learning” during 14 - 18 July 2020 organized by Balaji Institute of Technology & Science.

IT | FDP ON PYTHON PROGRAMMING

Dr A Christy Jeba Malar, Assoc. Professor, Dept. of IT, attended a four-day Online Faculty Development Program on “Python Programming” organized by Koneru Lakshmaiah Education Foundation during 15-18 July 2020 in association with IIT Bombay Spoken Tutorials.



IT | STTP ON ARTIFICIAL INTELLIGENCE IN HEALTH CARE

Zoom interface with controls: Mute, Zoom, Leave, Recording. The slide titled "Speech disorders" includes:

- Speech Sound Disorders**
 - Functional (Acquired)
 - Organic (Congenital)
- Main characteristics of speech disorders**
 - Unintelligible Speech
- Tasks - Machine learning algorithms**

SSN logo is visible at the bottom of the slide.

Zoom interface with controls: Recording. The slide titled "Backward pass" shows a neural network diagram and the following equations:

$$f = q \circ z, \frac{\partial f}{\partial z} = z \cdot \frac{\partial f}{\partial q} = q, \frac{\partial f}{\partial x} = \frac{\partial f}{\partial z} \cdot \frac{\partial z}{\partial x} = q \cdot \frac{\partial z}{\partial x}$$

$$q = x + y, \frac{\partial q}{\partial x} = 1, \frac{\partial q}{\partial y} = 1, \frac{\partial f}{\partial x} = \frac{\partial f}{\partial z} \cdot \frac{\partial z}{\partial x} + \frac{\partial f}{\partial y} \cdot \frac{\partial z}{\partial x}$$

Dr. Sajith Kecheril Sadanandan's screen



Ms M Malathi, Asst. Professor, Dept. of IT, participated in a One Week Short Term Course on **“Artificial Intelligence in Health Care”** during 16 - 22 July 2020 organized by IE(I) Coimbatore Local Centre in association with Kumaraguru College of Technology, Coimbatore.

ICE | FDP ON ELECTRIC VEHICLES DESIGN, DEVELOPMENT & CHALLENGES



Day 3, July 17, 2020 - Electric Vehicles Design, Development & Challenges

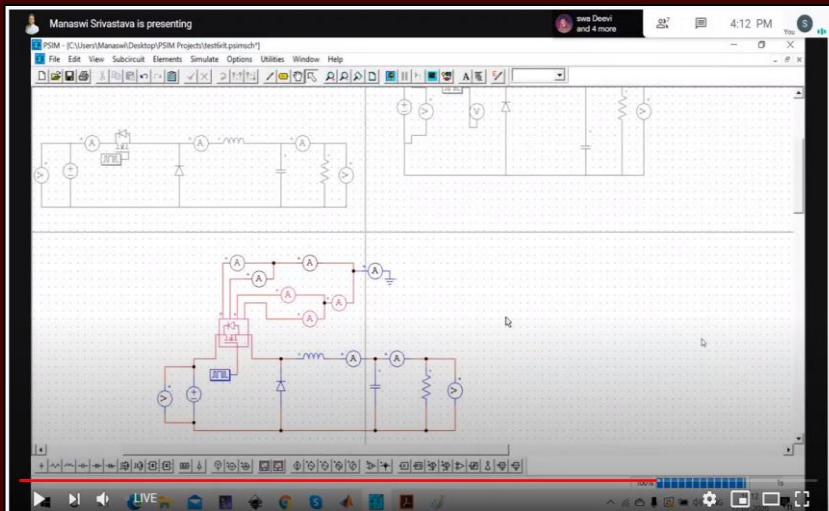

Day 3, July 17, 2020 - Electric Vehicles Design, Development & Challenges

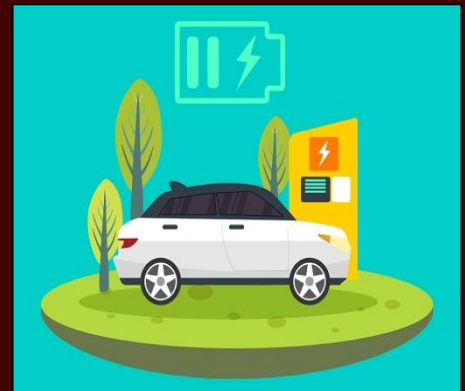

Dr S Narendiran, Assoc. Professor, Dept. of ICE, attended an FDP on **“Electric Vehicles Design, Development & Challenges”** organized by the Dept. of Electrical & Electronics, SWEC, Hyderabad during 15-21 July.

ICE | FDP ON ELECTRIC VEHICLES DESIGN, DEVELOPMENT & CHALLENGES

Battery

- Non rechargeable battery

A Voltaic Cell

© Encyclopaedia Britannica, Inc.



Chassis & power train

- Chassis of electric bus and diesel bus

ICE | FDP ON RECENT TRENDS IN ELECTRICAL ENGINEERING

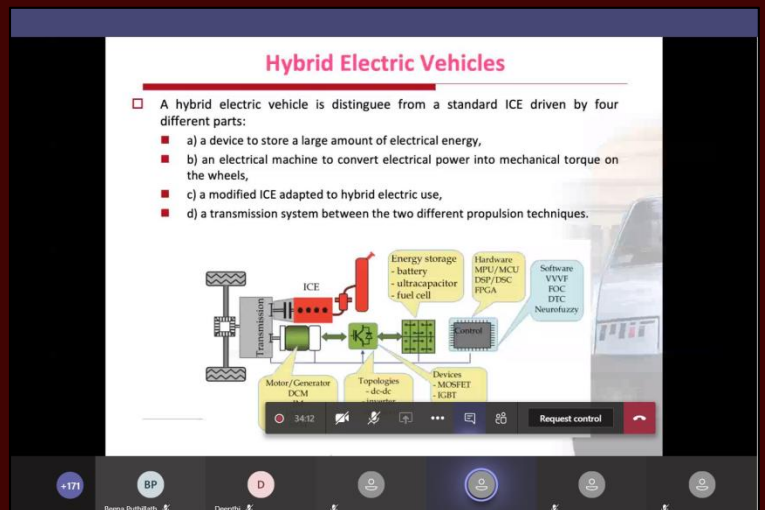
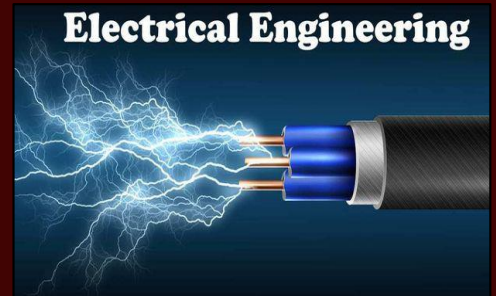

Dr S Narendiran, Asso. Professor, Dept. of ICE attending a seven-day FDP on **“Recent Trends in Electrical Engineering”** organized by the Dept. of EEE and IEEE PES & IAS Jt Student branch Chapter of Amrita School Of Engineering, Bangalore. Day 1 session was facilitated by Dr L Ashok Kumar, Professor, EEE, PSG-Coimbatore on 20 July 2020.

EEE | FDP ON EVOLUTION OF IoT & ITS REAL TIME APPLICATIONS



Dr P Ponmurugan, Assoc. Professor, Dept. of EEE, participated in the one week FDP on **"Evolution of IoT and its Real Time Applications"** organized by the Dept. of Computer Science and Engineering, Malla Reddy Institute of Technology and Science, Hyderabad during 13-17 July 2020.

Mr P Leninpugalhanthi, Asst. Professor, Dept. of EEE, successfully completed an online course on **"How to prepare your manuscript"**

conducted by Researcher Academy, Elsevier on 21 July 2020.



EEE | ONLINE COURSE | ELSEVIER RESEARCHER ACADEMY

ICE | FDP ON RECENT TRENDS IN ELECTRICAL ENGINEERING



High-frequency EM fields



- Headlines of recent years allows some insight into the various areas of public concern.
- Over the course of the past decade, numerous electromagnetic field sources have become the focus of health concerns, including power lines, microwave ovens, computer and TV screens, security devices, radars and most recently mobile phones and their base stations.

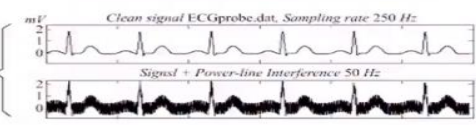
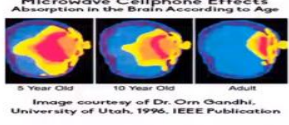

02:16







Request control



Dr. R.Azhagumurugan, Associate Professor, Department of Electrical and Electronics Engineering



+109

People ×

Currently in this meeting (12)

- AJ Aradhyula Jagadeesh
- A Azhagu (Guest)
- BC Bejawada Subba Ganesh Ch...
- B BLENU4EEE18009
- B BLENU4EEE18015
- B BLENU4EEE18049
- DR Devireddy Saiteja Reddy
- DM Dr. Rashmi M.R.
- DP Dr.Surekha Paneerselvam
- K k_deepa Organizer
- KR Katikapalli Revanth
- RR Rommala Sudheer Reddy



Measure of SI



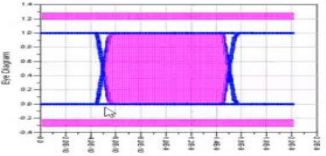
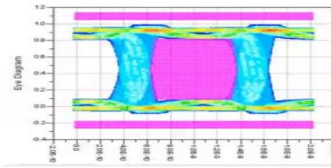



52:07







Request control



Dr. R.Azhagumurugan, Associate Professor, Department of Electrical and Electronics Engineering



+153

Dr S Narendiran, Asso. Professor, Dept. of ICE, attended a seven-day FDP on **“Recent Trends in Electrical Engineering”** organized by the Dept. of EEE and IEEE PES & IAS Jt Student branch Chapter of Amrita School Of Engineering, Bangalore. Day 2 Session was facilitated by Dr. R. Azhagumurugan, Dept of EEE, Sri Sairam Engineering College, Chennai on 21 July 2020.

CSE | FDP ON PYTHON PROGRAMMING



Dr M Deva Priya, Assoc. Professor and Ms M S Sruthi, Asst. Professor, Dept. of CSE, attended a four-day Faculty Development Programme on "Python Programming" during 15 – 18 July 2020 organized by Koneru Lakshmaiah Education Foundation, Hyderabad in association with IIT Bombay Spoken Tutorials funded by MHRD.

ICE | FDP ON ELECTRIC VEHICLES DESIGN, DEVELOPMENT & CHALLENGES

Dr.M.Lakshmi Swarupa is talking

Necessary data for designing of a E-bike

- Deciding the model of the bike (existing design or new design or retrofitting)
- Type of bike (Pedaling or Hand or both)
- Weight of the components, passengers, curb weight and etc
- Types of components – Supply, motors, Battery, battery drive, controllers, converters, Battery charger and etc.
- Parameters of E-bike are: Driving cycle, weight, torque, speed, current, voltage, power, rating of the battery and etc.
- Calculations in terms of Electrical, mechanical form (Vehicle dynamics formulae's).
- Testing procedures and standards.

Dr.M.La



Sridevi Women's Engineering College
Department of Electrical & Electronics Engineering



Certificate of Participation

For
Faculty development Program

In Association with

SKILL SHARK

This is to certify that **Dr.S.Narendiran** from Sri Krishna college of technology, coimbatore has participated in the National level Faculty development program on '**Electric Vehicles Design, Development & Challenges**' organized by the Department of Electrical and Electronics Engineering in association with SkillShark held from 15.07.2020 to 21.07.2020.

G.V.Swathi
Coordinator-FDP
SWEC

Ashhar Ahmed
Program Director
SkillShark

Dr.D.Padmavathi
Convener & HOD-EEE
SWEC

Dr.B.L.Malleswari
Principal
SWEC

Dr S Narendiran, Assoc. Professor, Dept. of ICE, attended a six-day FDP on "Electric Vehicles Design, Development & Challenges" organized by the Department of Electrical & Electronics, SWEC, Hyderabad during 15- 21 July 2020. Day 6 session was facilitated by Dr.Lakshmi Swarupa, CVR COE on 21 July 2020.

EEE | INTERNATIONAL FDP ON EXPLORING THE NUANCES OF DEEP LEARNING FOR RESEARCH APPLICATIONS – A DEEPER EXPERIENCE



Mr P Leninpugalhanthi, Asst. Professor, Department of EEE, participated in the five-day International FDP on “Exploring the nuances of deep learning for research applications – A deeper experience” organized by the Dept. of ECE, Karunya Institute of Technology and Sciences, Coimbatore during 13-17 July 2020.

EEE | FDP ON MICROGRID : OPERATION & CONTROL



Dr K Gaayathry, Asst. Professor, Dept. of EEE, participated in the National level virtual FDP on “Microgrid: Operation & Control” organized by the Dept. of Electrical and Electronics Engineering, SSN College of Engineering, Chennai during 16-18 July 2020.

ICE | FDP ON RECENT TRENDS IN ELECTRICAL ENGINEERING

Micro-grid – A off-spring of the main Grid

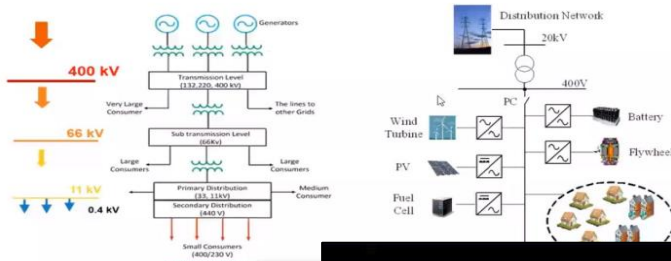

Component Requirements

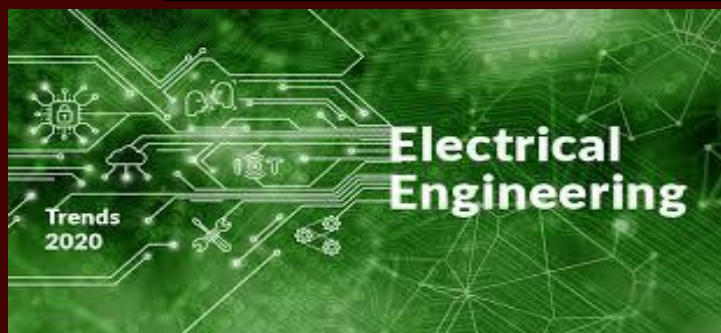
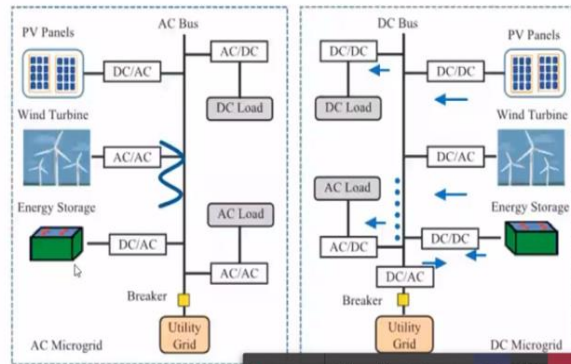

Dr S Narendiran, Assoc. Professor, Dept. of ICE, attended a seven-day FDP on “Recent Trends in Electrical Engineering” organized by the Dept. of EEE and IEEE PES & IAS JT Student branch Chapter of Amrita School Of Engineering, Bangalore.

ECE | STTP ON ARTIFICIAL INTELLIGENCE IN HEALTH CARE



Dr K Sumathi, Professor, Dept. of ECE has been certified for attended one week STTP on **“Artificial Intelligence in Health Care”** organized by Kumaraguru College of Technology from 16 July 2020 to 22 July 2020.

ECE | STTP ON OPTIMIZATION TECHNIQUES THROUGH MACHINE LEARNING FOR WIRELESS AND IOT

Mr R R Thirrunavukkarasu, Asst. professor, Dept. of ECE has been certified for attended one week STTP on **“Optimization Techniques through Machine Learning for wireless And IoT”** organized by Malla Reddy Engineering Collge For Women from 13 July 2020 to 18 July 2020.





MEETINGS & DISCUSSIONS



SPECIAL EDITION 9



@skctdigest



@skctofficial



digestfeedback@skct.edu.in

MECH | DEPARTMENT MEETING

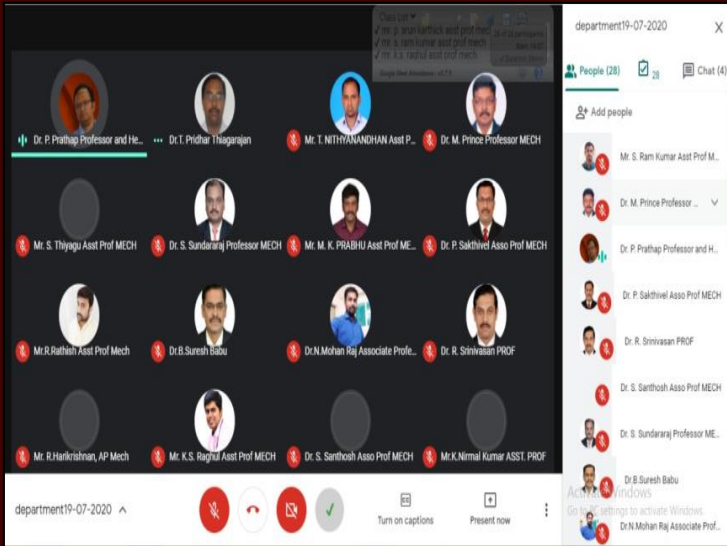

Dr P Prathap, Professor and Head, Dept. of Mechanical Engineering, convened a meeting with the Member of Faculty in the Dept. of Mech Engineering on 19 July 2020.

MECH | TUTOR WARD MEETING

Members of Faculty in the Dept. of Mechanical Engineering, conducted the Tutor Ward meeting with their respective wards.

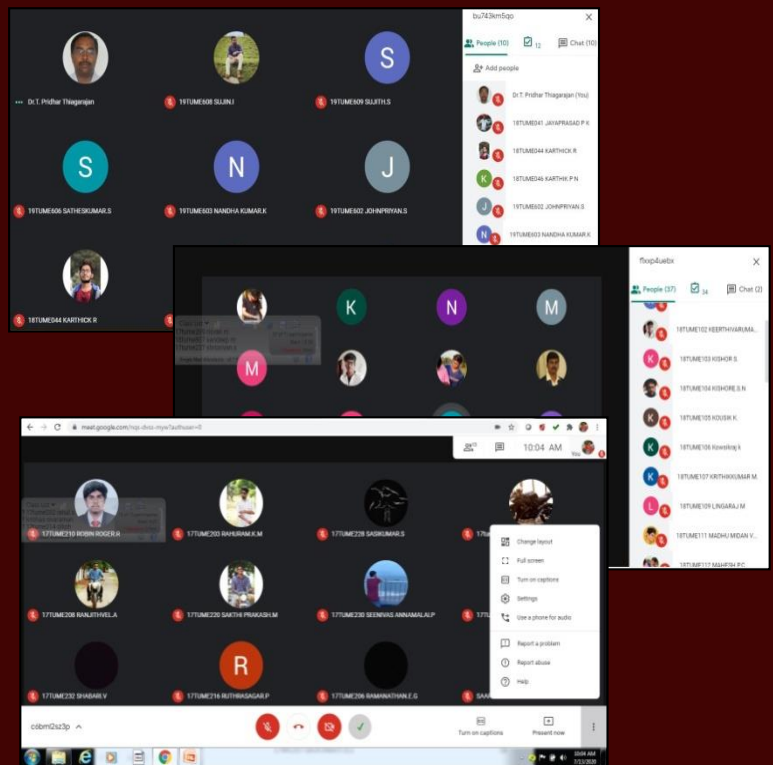

IT | DEPARTMENT MEETING

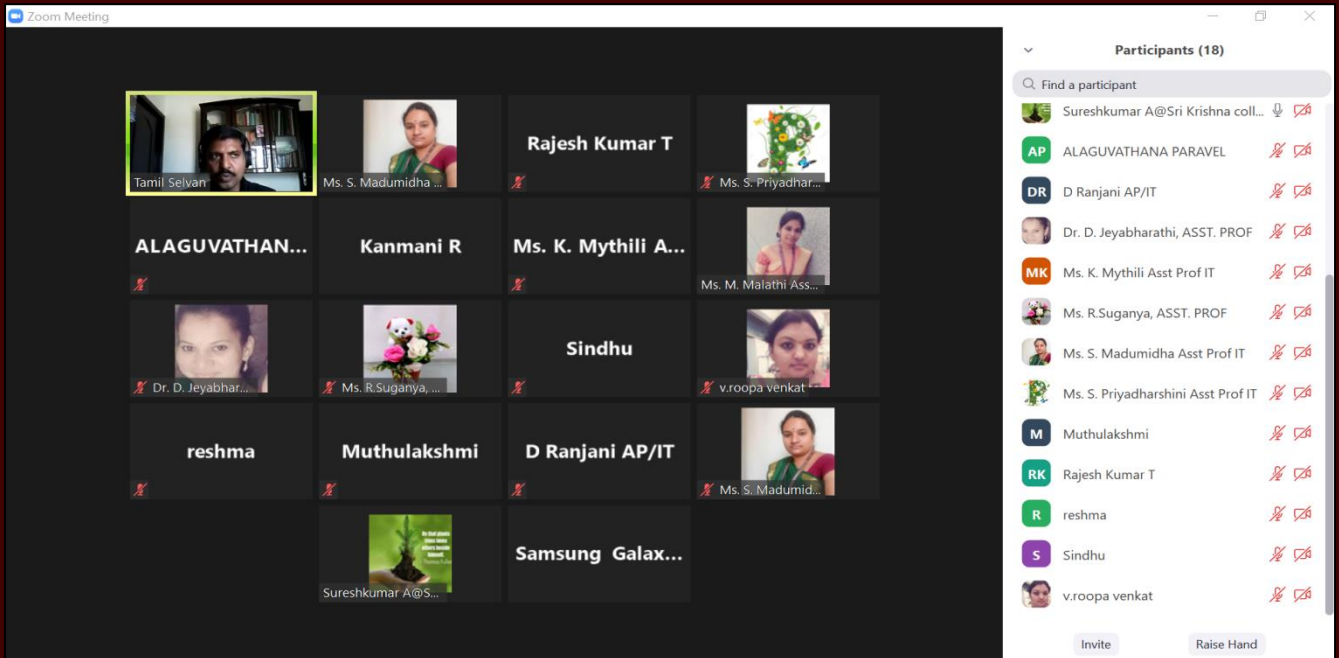
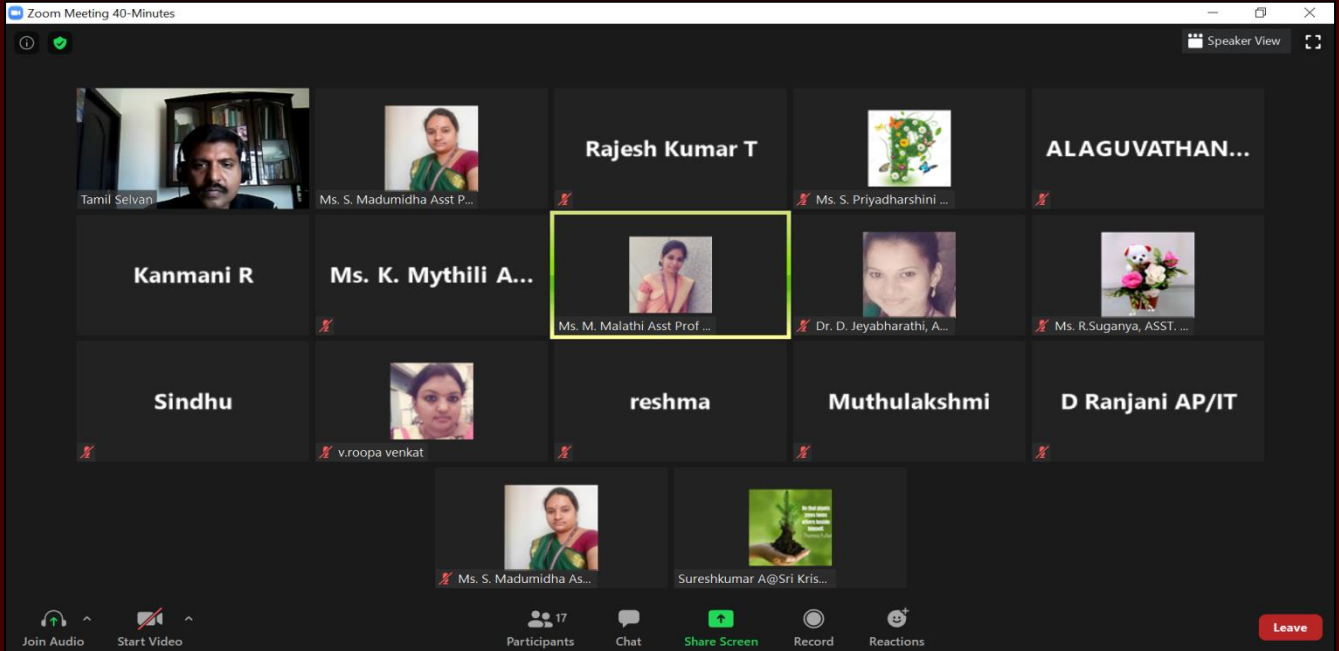

Dr G M Tamilselvan, Professor & Head, Dept. of IT convened a meeting with the Members of Faculty in the Dept. of IT to discuss the Online Classes and Placement Activities.



EVENTS ORGANIZED



SPECIAL EDITION 9



@skctdigest



@skctofficial



digestfeedback@skct.edu.in

SoM | WEBINAR ORGANIZED ON START UP TO SCALE UP

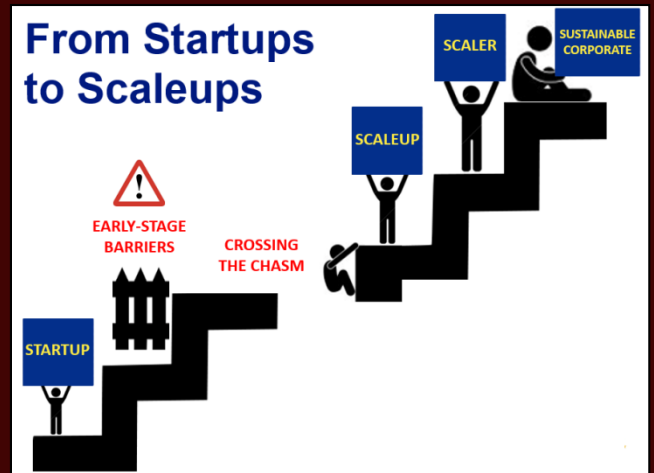

School of Management (SoM) organized a Webinar on “**Start up to Scale up**” on 18 July 2020. Mr Sarathbabu Elumalai, CEO & Founder, FoodKing, facilitated the session.

TODAY'S QUOTES

“

If you cannot do great things, do small things in a great way."

Napoleon Hill

**"SUCCESS IS THE SUM OF
SMALL EFFORTS, REPEATED
DAY IN AND DAY OUT"**

Robert Collier

▲ SALES HACKER

